

FreeZone® Freeze Dryers & Accessories





Labconco for life.

The science of freeze drying protects and improves our lives in so many ways. Life-saving vaccines. Cleaner water. Cleaner air. Better food. Curing disease. Prolonging life. Freeze dry research matters.

The engineering of freeze drying equipment protects and improves your research process in many important ways as well. Results. Consistency. Drying time. End point completion notification. Reduced maintenance. Eliminating costly mistakes. Quality equipment matters.

Labconco is your partner for the life of your freeze drying equipment, not just the warranty period. Which can be a long time, because we don't take shortcuts in design or production, and we don't use cut-rate materials. Everything we make is specifically designed for the lab and your ease of use. And we make it to last. Labconco, for life.

The Labconco logo consists of the word "LABCONCO" in a bold, white, sans-serif font, centered within a dark blue, horizontally-oriented oval shape. The oval has a slight gradient and a registered trademark symbol (®) to the right of the text.

LABCONCO®



Table of Contents

Introduction	1	FreeZone® Stoppering Tray Dryers	26
Labconco Advantages	4	FreeZone® Bulk Tray Dryers	32
Lyo-Works™ Operating System	6	FreeZone® Small Tray Dryers	34
FreeZone® Freeze Dryers		FreeZone® Tray Drying Accessories	35
Features & Benefits	7	Drying Accessories	
Build a Freeze Dry System	8	Chambers	36
Selection Guide	10	Product Shelves	37
2.5 Liter Benchtop	12	Test Tube Racks & Manifolds	38
4.5 Liter Benchtop	14	Stoppering Chambers & Lids	39
8 Liter Benchtop	16	Secondary Traps	40
6, 12 & 18 Liter Console	18	Vacuum Pumps	
FreeZone® Legacy™ Freeze Dryers		Selection Guide & Accessories	41
2.5 Liter Benchtop	21	Rotary Vane	42
6 Liter Benchtop	22	Combination	43
Dry Ice Benchtop Freeze Dryer	23	Scroll	44
Tray Dryers		PrimeMate™ Oil Change Systems	45
FreeZone® Legacy™ Triad™ Freeze Dryers	24	Fast-Freeze® Flasks & Adapters	46
		Fast-Freeze® Flask Accessories	47
		End-Zone™ Starter Kit & Add-On Kit	48
		FreeZone® Benchtop Shell Freezers	49
		Serum Bottles, Ampules & Accessories	50
		Carts, Shelves & Gauges	51



Freeze dryers for today.

Labconco has been helping laboratories stay ahead of the freeze drying curve since 1974. Each new generation of freeze dryers takes quality, durability and technology to the next level. So, while many of our early freeze dryers still work today, your lab will work smarter with the advanced Lyo-Works™ operating system in our latest FreeZone Freeze Dryers.

Alerts and status updates come to you via email. And our exclusive End-Zone™ end point detection accessory notifies you when your samples are dry (no more uncertainty and over drying). Now you can worry less and save time.

Keep data at your fingertips. Lyo-Works OS lets you program parameters and monitor status in real time, and even stores your data so you can repeat protocols and use it for analysis.

Make anything possible with our broad line of freeze dryers, built-in options and expanded accessory selection.

- Sizes from 2.5 to 18 liters
- Collector temperatures: -50° C, -84° C, -105° C
- Benchtop or console
- PTFE*-coated chambers and coils
- Purge valve
- Built-in mini drying chambers
- Legacy™ models in 2.5 and 6 liter sizes
- Shell freezers
- Bulk drying chambers
- Stoppering tray dryers
- Rotary vane, combination and scroll pumps
- Flasks, serum bottles and ampules

*Polytetrafluoroethylene

The Labconco advantage.

Quality and durability.

You don't buy freeze dryers very often, so it really matters to get it right. We make it our mission to build ours to the highest possible standards using superior quality materials. That's why they last and last.

- Durable powder-coated and stainless steel construction
- PTFE-coated collector chambers to resist corrosion
- Wear-resistant, quick-disconnect drain hoses

Data collection.

You base your science on your samples. Lyo-Works OS lets you monitor and store your samples' conditions so you can prove their integrity right from your freeze dryer.

- Real time on-screen tables and graphs to immediately show variables that may be affecting your samples
- Data and program storage for repeatability of protocols
- Data transfer via Ethernet or USB port (no additional recorders or computers needed)

Staying connected.

We understand the value of your samples. Often, they are irreplaceable. You want to know how they are doing every step of the way.

- Get email updates on your samples' status
- Get email notifications when your freeze dryer's set points are outside of normal range
- Know when samples are dry with End-Zone alerts

Vacuum pump protection.

Pump problems slow you down and can be expensive. FreeZone safety features help eliminate pump damage.

- Auto shut down of your freeze dryer if 5 mBar isn't reached during start up
- Patented* drain line sensor that detects moisture before it can damage your pump to prevent a dry pump or oil mist in the lab
- Vacuum break valve that prevents oil backstreaming during power outages

Plug-and-play accessories.

Select the drying accessory you need now and enjoy the flexibility to change it later when your science changes.

- Operate your accessory from your freeze dryer's touch screen display
- More accessories to choose from including manifolds, drying chambers and shelves
- Easy-to-add End-Zone for detection of end point of your samples in flasks

*U.S. Patent No. 6,968,631



LABCONCO®

Lyo-Works™ Operating System

Features & Benefits

Programs

Lets you create, edit, view and initiate programs. Stores up to 30 programs with up to 16 steps each.

Settings

Select language, security code, sensor calibration, time/date/time zone, alert emails and other settings.

Sensors

Displays temperature values for sensors.

Tray Dryers

Allows you to program or manually control shelf temperatures of installed tray dryers with temperature control.

Data Logging

Starts/stops logging. View the data in table or graph form.

End Point Detection

When End-Zone is installed, indicates when end point is reached for each sensor.

Home Screen

Get at-a-glance collector temperature, vacuum pressure, and, if equipped, built-in shell freezer temperature.

Help

Access diagnostic tools and user manuals.

Auto

Initiates the start up sequence: collector cool down, vacuum pull down and optional purge valve. Ensures collector reaches -40° C before vacuum is applied.



Shell Freezer

Controls optional built-in shell freezer.

Collector

Manually starts/stops the collector and starts/stops defrost.

Vacuum

Manually starts/stops the vacuum pump.

Purge

Controls the optional purge valve.

Lyo-Works is more than a large touch screen display. It's a set of powerful controls and useful insights about your freeze drying process. Lyo-Works gives you greater peace of mind about the integrity of your samples throughout lyophilization, even when you're not in the lab.



USB port and Ethernet connection

Lets you easily output Lyo-Works data in CSV format to a flash drive or via email.

See how Lyo-Works works at labconco.com/lyo-works.

FreeZone® Freeze Dryers

Features & Benefits

Attachment port connects to drying accessory (sold separately).

Optional built-in shell freezer or mini vacuum drying chamber available on some console models.



Built-in shell freezer with stainless steel bath and separate refrigeration system holds flasks up to 1200 ml.



Built-in mini vacuum drying chamber holds small samples, either in bulk or in small containers such as serum bottles.



Made in the U.S.A.



CE marking

All 230V, 50 Hz models conform to the CE (European Community) directives.



ETL listed

All 115/230V, 60 Hz models carry the ETL mark signifying they are certified to UL and CAN/CSA standards for laboratory equipment.

* Labconco exclusive feature

*U.S. Patent No. 6,968,631



Upright, stainless steel collector chamber speeds and simplifies defrost. Available with PTFE-coated collector coil and chamber for additional corrosion resistance.

Quick-disconnect drain hose fitting for convenient defrost.

Vacuum control valve maintains set point vacuum level to speed the freeze drying process.

Hot gas defrost automatically shuts off when defrosting is complete.

* **Vacuum break valve** prevents oil backstreaming by bleeding air into the system when power to the freeze dryer or pump is shut off. After brief power outages, freeze dryer restarts and refrigeration and vacuum resume operation. For longer power outages when the collector warms above safe limits, it will not automatically restart, preventing melted samples from being drawn into the collector and potentially harming the pump.

* **Patented* moisture sensor** protects the vacuum pump by preventing refrigeration or vacuum start-up when moisture is detected in collector chamber area.

* **Durable steel cabinet** has casters for mobility and a two-piece brushed stainless steel front panel. Left side panel is easy to remove for access to the vacuum pump (pump sold separately). A window lets you see pump oil status. Benchtop models fit atop countertops and lab carts.

HCFC/CFC-free refrigeration ensures rapid, environmentally-safe cooling.

Optional purge valve isolates vacuum pump from the freeze dryer. The pump starts and warms the oil while the collector cools, before pulling vacuum. Can be used after run to purge contaminants from oil to extend pump life.

Full one year warranty against defects in materials and workmanship.

FreeZone® Freeze Dryers

Build Your Freeze Dry System

1. Select freeze dryer

See pages 10-11.



Benchtop



Mobile Console

2. Select drying accessory

See pages 28-39.



Manifold



Chamber



Heated Shelf Chamber



Tray Dryer

3. Select vacuum pump

See pages 41-44.



Rotary Vane Pump



Combination Pump



Scroll Pump

4. Select sample container(s)

See pages 35, 38, 46, 50.



Glassware

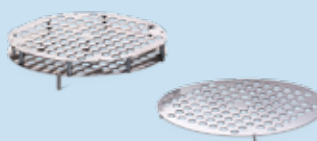

Rack

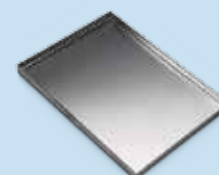

Tray

5. Select optional accessories

See pages 48-49, 51.



End-Zone™



Shell Freezer



Cart

When choosing a FreeZone Freeze Dryer, make sure you add all of the components to make a complete system.

FreeZone® Freeze Dryers

Freeze Dry System Sample Builds



<p>1. Freeze dryer FreeZone 2.5 Liter Benchtop Freeze Dryer</p>	<p>1. Freeze dryer FreeZone 8 Liter Benchtop Freeze Dryer</p>	<p>1. Freeze dryer FreeZone 12 Liter Console Freeze Dryer</p>
<p>2. Drying accessory Small Tray Dryer</p>	<p>2. Drying accessory 8-Port Manifold</p>	<p>2. Drying accessory FreeZone Bulk Tray Dryer with 6-Port Tray Dryer Manifold</p>
<p>3. Vacuum pump Rotary Vane Pump</p>	<p>3. Vacuum pump Scroll Pump</p>	<p>3. Vacuum pump Rotary Vane Pump</p>
<p>4. Sample container(s) None required for bulk samples shown</p>	<p>4. Sample container(s) Fast-Freeze Flasks, Stainless Steel Adapters, Ampules, Ampule Pod</p>	<p>4. Sample container(s) Test Tube/Microcentrifuge Tube Rack, Fast-Freeze Flasks, Stainless Steel Adapters</p>
<p>5. Optional accessories FreeZone Cart</p>	<p>5. Optional accessories FreeZone Cart</p>	<p>5. Optional accessories None shown</p>

We're here to help.

When you're ready to complete the selection process, we can make it easy.

To configure your complete freeze dry system online, go to labconco.com/freezone-configurator to select the components and catalog numbers you need.

You can narrow your evaporation choices by using our selector at labconco.com/evaporator-selector.

Prefer to talk to a freeze dry application specialist? We'd love to help. Just call us at (800) 821-5525 or (816) 333-8811.

FreeZone® Freeze Dryers

Benchtop Models Selection Guide



2.5 Liters

2.5 Liters

2.5 Liters

4.5 Liters

6 Liters

8 Liters

Operating System	Lyo-Works touch screen	Legacy LCD	Legacy Triad LCD	Lyo-Works touch screen	Legacy LCD	Lyo-Works touch screen
-50° C (-58° F) Collector/ Refrigeration For aqueous samples	1/3 hp refrigeration system Removes 2 L of water in 24 hours*	1/3 hp refrigeration system Removes 2 L of water in 24 hours*		1/3 hp refrigeration system Removes 2 L of water in 24 hours*	3/4 hp refrigeration system Removes 4 L of water in 24 hours*	3/4 hp refrigeration system Removes 4 L of water in 24 hours*
-84° C (-119° F) Collector/ Refrigeration For samples with low eutectic points, including acetonitrile	Two 1/3 hp refrigeration systems Removes 2.2 L of water in 24 hours*		Two 1/3 hp refrigeration systems Removes 1.8 L of water in 24 hours*	Two 1/3 hp refrigeration systems Removes 4 L of water in 24 hours*		
-105° C (-157° F)** Collector/ Refrigeration For samples with very low eutectic points including acetonitrile and dilute methanol and ethanol				Two 1/2 hp refrigeration systems Removes 2.5 L of water in 24 hours*		
Built-In Options			Temperature-controlled stoppering tray dryer included*			
Pages	12-13	21 & 23	24-25	14-15	22-23	16-17

*Freeze drying rate will be lower for samples other than shell-frozen plain water.

** -105° C (-157° F) at 60 Hz, -102° C (-152° F) at 50 Hz

FreeZone® Freeze Dryers

Console Models Selection Guide



6 Liters

6 Liters

12 Liters

12 Liters

18 Liters

18 Liters

Operating System	Lyo-Works touch screen	Lyo-Works touch screen	Lyo-Works touch screen	Lyo-Works touch screen	Lyo-Works touch screen	Lyo-Works touch screen
-50° C (-58° F) Collector/ Refrigeration For aqueous samples	3/4 hp refrigeration system Removes 4 L of water in 24 hours*	3/4 hp refrigeration system Removes 4 L of water in 24 hours*	1 hp refrigeration system Removes 8 L of water in 24 hours*	1 hp refrigeration system Removes 8 L of water in 24 hours*	1-1/2 hp refrigeration system Removes 10 L of water in 24 hours*	1-1/2 hp refrigeration system Removes 10 L of water in 24 hours*
-84° C (-119° F) Collector/ Refrigeration For samples with low eutectic points, including acetonitrile	Two 1/3 hp refrigeration systems Removes 4 L of water in 24 hours*	Two 1/3 hp refrigeration systems Removes 4 L of water in 24 hours*	Two 3/4 hp refrigeration systems Removes up to 4 L in 24 hours*	Two 3/4 hp refrigeration systems Removes up to 4 L in 24 hours*		
Built-In Options Available	Purge valve Mini vacuum drying chamber Shell freezer available with -50° C models	FreeZone Stopping Tray Dryer included	Purge valve Mini vacuum drying chamber	FreeZone Stopping Tray Dryer included	Purge valve Mini vacuum drying chamber	FreeZone Stopping Tray Dryer included
Pages	18-19	26-29	18-19	26-29	18 & 20	26-28 & 30

*Freeze drying rate will be lower for samples other than shell-frozen plain water.

FreeZone® 2.5 Liter Benchtop Freeze Dryers

Specifications



Application suitability:

- Light sample loads
- Limited floor space

All models feature:

- Upright stainless steel collector coil capable of holding 2.5 L of ice before defrosting. Collector lid, 3/4" thick, has neoprene gasket and 3" dia. port to connect drying accessories (sold separately)
- * Full color, 5" capacitive touch screen with Lyo-Works OS:
 - Real time display of collector temperature, vacuum level and optional End-Zone end point detection
 - Automatic and manual start-up modes for collector cool down and vacuum pull down
 - Vacuum set point, alerts, diagnostic tests, user manual, defrost control and optional drying accessory control
 - Data logging stores and displays data in table or graph format, and may be exported via USB
 - Settings include language (English, Spanish, French, German, or Italian), time, temperature (°C or °F) and vacuum (mBar, Torr or Pa)
 - Alerts can be emailed to user-entered addresses via Ethernet connection
 - Maintenance alert settings for vacuum pump and refrigeration
 - Security lock out
- * USB port and Ethernet connection
- End-Zone compatible (End-Zone Starter Kit sold separately. See page 48)
- Hot gas defrost with auto shut off at +65° C (+149° F)
- Vacuum control valve

- * Vacuum break valve
- * Patented* moisture sensor
- Compact benchtop design with a small footprint
- Stainless steel and powder-coated steel exterior
- Quick-disconnect drain hose fitting with hose connector. 18", 1/4" ID silicone tubing and clamp included
- Electrical receptacle for vacuum pump connection
- 3/4" OD vacuum connection, 50" of 3/4" ID vacuum hose and two clamps

Models conform to the following standards:

- UL Standard 61010-1 (115/230V, 60 Hz models)
- CAN/CSA C22.2 No. 61010-1 (115/230V, 60 Hz models)
- CE Conformity marking (230V, 50 Hz models)

Options include:

- Single 1/3 hp HCFC/CFC-free refrigeration system to cool collector to -50° C (-58° F) or two 1/3 hp HCFC/CFC-free refrigeration systems to cool collector to -84° C (-119° F). Collectors reaching -50° C include acrylic lid. Collectors reaching -84° C include stainless steel lid
- PTFE-coated collector coil and chamber for corrosive compounds
- Region-specific electrical plug configurations

All models require (not included):

- Vacuum pump with a displacement of at least 98 L/min, 0.002 mBar ultimate pressure and fitting for 3/4" ID vacuum hose. See pages 41-44
- Drying accessory. See pages 34, 36-38
- Freeze dry glassware if not bulk freeze drying. See pages 46, 50



* Labconco exclusive feature

*U.S. Patent No. 6,968,631

FreeZone® 2.5 Liter Benchtop Freeze Dryers

Ordering Information

Catalog Number Configurator:

Use this key to configure the nine digit catalog number to order your FreeZone 2.5 Liter Benchtop Freeze Dryer.

7 0 2 0 0

Select the **REFRIGERATION TEMPERATURE** of your freeze dryer's collector. This is the second digit of your catalog number.

- 0** = -50° C (-58° F). For samples containing water. Not for use with samples containing acetonitrile, methanol or ethanol. Collector is capable of removing 2 liters of water in 24 hours.*
- 1** = -84° C (-119° F). For low eutectic point samples containing water or acetonitrile. Not for use with samples containing methanol or ethanol. Collector is capable of removing 2.2 liters of water in 24 hours.*

Select the **COLLECTOR COIL** and **CHAMBER MATERIAL** of your freeze dryer. This is the sixth digit of your catalog number.

- 1** = Stainless steel
- 2** = PTFE-coated stainless steel

Select the **ELECTRICAL CONFIGURATION** and **PLUG TYPE** of your freeze dryer. These are the eighth and ninth digits of your catalog number.

- 00** = 115V, 60 Hz, with 20A plug for North America
- 10** = 230V, 60 Hz, with plug for North America
- 15** = 230V, 60 Hz, with plug for Saudi Arabia
- 30** = 230V, 50 Hz, with Schuko plug
- 40** = 230V, 50 Hz, with plug for China/Australia
- 50** = 230V, 50 Hz, with plug for Great Britain (UK)
- 70** = 230V, 50 Hz, with plug for India

Electrical Requirements

Collector Capacity	Refrigeration Temperature	Volts	Amps	Note
2.5 L	-50° C	115	14**	Requires 20 amp dedicated circuit
2.5 L	-50° C	230	7†	
2.5 L	-84° C	115	16**	Requires 20 amp dedicated circuit
2.5 L	-84° C	230	10†	

Plug Configurations



115V, 60 Hz, 20A
for North America



230V, 60 Hz
for North America



230V, 60 Hz
for Saudi Arabia



230V, 50 Hz
Schuko



230V, 50 Hz
for China/Australia



230V, 50 Hz
for Great Britain (UK)



230V, 50 Hz
for India

Actual Dimensions & Shipping Weights

Refrigeration Temperature	Overall Dimensions (w x d x h)	Shipping Weight
-50° C (-58° F)	14.5" x 19.2" x 16.9" (36.8 x 48.8 x 42.9 cm)	107 lbs. (49 kg)
-84° C (-119° F)	14.5" x 24.5" x 16.9" (36.8 x 62.2 x 42.9 cm)	133 lbs. (60 kg)

*Freeze drying rate will be lower for samples other than shell-frozen plain water. For optimum performance, room temperature should be 21° C (70° F) or colder.

**System amperage shown includes 8 amp maximum vacuum pump rating.

†System amperage shown includes 4.5 amp maximum vacuum pump rating.

FreeZone® 4.5 Liter Benchtop Freeze Dryers

Specifications



Application suitability:

- Light to moderate sample loads
- Limited floor space

All models feature:

- Upright stainless steel collector coil capable of holding 4.5 L of ice before defrosting. Collector lid, 3/4" thick, has neoprene gasket and 3" dia. port to connect drying accessories (sold separately)
- * Full color, 5" capacitive touch screen with Lyo-Works OS:
 - Real time display of collector temperature, vacuum level and optional End-Zone end point detection
 - Automatic and manual start-up modes for collector cool down and vacuum pull down
 - Vacuum set point, alerts, diagnostic tests, user manual, defrost control and optional drying accessory control
 - Data logging stores and displays data in table or graph format, and may be exported via USB
 - Settings include language (English, Spanish, French, German, or Italian), time, temperature (°C or °F) and vacuum (mBar, Torr or Pa)
 - Alerts can be emailed to user-entered addresses via Ethernet connection
 - Maintenance alert settings for vacuum pump and refrigeration
 - Security lock out
- * USB port and Ethernet connection
- End-Zone compatible (End-Zone Starter Kit sold separately. See page 48)
- Hot gas defrost with auto shut off at +65° C (+149° F)
- Vacuum control valve
- * Vacuum break valve

* Labconco exclusive feature

* Patented* moisture sensor

- Compact benchtop design with a small footprint
- Stainless steel and powder-coated steel exterior
- Quick-disconnect drain hose fitting with hose connector. 18", 1/4" ID silicone tubing and clamp included
- Electrical receptacle for vacuum pump connection
- 3/4" OD vacuum connection, 50" of 3/4" ID vacuum hose and two clamps

Models conform to the following standards:

- UL Standard 61010-1 (115/230V, 60 Hz models)
- CAN/CSA C22.2 No. 61010-1 (115/230V, 60 Hz models)
- CE Conformity marking (230V, 50 Hz models)

Options include:

- Single 1/3 hp HCFC/CFC-free refrigeration system to cool collector to -50° C (-58° F), two 1/3 hp HCFC/CFC-free refrigeration systems to cool collector to -84° C (-119° F) or two 1/2 hp HCFC/CFC-free refrigeration systems to cool collector to -105° C (-157° F) at 60 Hz or -102° C (-152° F) at 50 Hz. Collectors reaching -50° C include acrylic lid. Collectors reaching -84° C or -105° C include stainless steel lid
- PTFE-coated collector coil and chamber for corrosive compounds
- Region-specific electrical plug configurations

All models require (not included):

- Vacuum pump with a displacement of at least 98 L/min, 0.002 mBar ultimate pressure and fitting for 3/4" ID vacuum hose. See pages 41-44
- Drying accessory. See pages 34, 36-39
- Freeze dry glassware if not bulk freeze drying. See pages 46, 50



*U.S. Patent No. 6,968,631

FreeZone® 4.5 Liter Benchtop Freeze Dryers

Ordering Information

Catalog Number Configurator:

Use this key to configure the nine digit catalog number to order your FreeZone 4.5 Liter Benchtop Freeze Dryer.

7 0 4 0 0

Select the **REFRIGERATION TEMPERATURE** of your freeze dryer's collector. This is the second digit of your catalog number.

- 0** = -50° C (-58° F). For samples containing water. Not for use with samples containing acetonitrile, methanol or ethanol. Collector is capable of removing 2 liters of water in 24 hours.*
- 1** = -84° C (-119° F). For low eutectic point samples containing water or acetonitrile. Not for use with samples containing methanol or ethanol. Collector is capable of removing 4 liters of water in 24 hours.*
- 2** = -105° C (-157° F) at 60 Hz or -102° C (-152° F) at 50 Hz. For low eutectic point samples containing water, acetonitrile or dilute methanol or ethanol. Collector is capable of removing 2.5 liters of water in 24 hours.*

Select the **COLLECTOR COIL** and **CHAMBER MATERIAL** of your freeze dryer. This is the sixth digit of your catalog number.

- 1** = Stainless steel
- 2** = PTFE-coated stainless steel

Select the **ELECTRICAL CONFIGURATION** and **PLUG TYPE** of your freeze dryer. These are the eighth and ninth digits of your catalog number.

- 00** = 115V, 60 Hz, with 20A plug for North America
- 10** = 230V, 60 Hz, with plug for North America
- 15** = 230V, 60 Hz, with plug for Saudi Arabia
- 30** = 230V, 50 Hz, with Schuko plug
- 40** = 230V, 50 Hz, with plug for China/Australia
- 50** = 230V, 50 Hz, with plug for Great Britain (UK)
- 70** = 230V, 50 Hz, with plug for India

Electrical Requirements

Collector Capacity	Refrigeration Temperature	Volts	Amps	Note
4.5 L	-50° C	115	14**	Requires 20 amp dedicated circuit
4.5 L	-50° C	230	7†	
4.5 L	-84° C & -105° C	115	16**	Requires 20 amp dedicated circuit
4.5 L	-84° C & -105° C	230	10†	

Plug Configurations



115V, 60 Hz, 20A for North America



230V, 60 Hz for North America



230V, 60 Hz for Saudi Arabia



230V, 50 Hz Schuko



230V, 50 Hz for China/Australia



230V, 50 Hz for Great Britain (UK)



230V, 50 Hz for India

Actual Dimensions & Shipping Weights

Refrigeration Temperature	Overall Dimensions (w x d x h)	Shipping Weight
-50° C (-58° F)	16.5" x 22.4" x 18.9" (41.9 x 56.9 x 48.0 cm)	109 lbs. (49 kg)
-84° C (-119° F)	22.5" x 26.5" x 18.5" (57.2 x 67.3 x 47.0 cm)	166 lbs. (75 kg)
-105° C (-157° F)	22.5" x 26.5" x 18.5" (57.2 x 67.3 x 47.0 cm)	172 lbs. (78 kg)

*Freeze drying rate will be lower for samples other than shell-frozen plain water. For optimum performance, room temperature should be 21° C (70° F) or colder.

**System amperage shown includes 8 amp maximum vacuum pump rating.

†System amperage shown includes 4.5 amp maximum vacuum pump rating.

FreeZone® 8 Liter -50° C Benchtop Freeze Dryers

Specifications



Application suitability:

- Moderate sample loads
- Limited floor space

All models feature:

- Upright stainless steel collector coil capable of removing 4 L of water in 24 hours and holding 8 L of ice before defrosting. Acrylic collector lid, 3/4" thick, has neoprene gasket and 3" dia. port to connect drying accessories (sold separately)
- Single 3/4 hp HCFC/CFC-free refrigeration system to cool collector to -50° C (-58° F)
- * Full color, 5" capacitive touch screen with Lyo-Works OS:
 - Real time display of collector temperature, vacuum level and optional End-Zone end point detection
 - Automatic and manual start-up modes for collector cool down and vacuum pull down
 - Vacuum set point, alerts, diagnostic tests, user manual, defrost control and optional drying accessory control
 - Data logging stores and displays data in table or graph format, and may be exported via USB
 - Settings include language (English, Spanish, French, German, or Italian), time, temperature (° C or ° F) and vacuum (mBar, Torr or Pa)
 - Alerts can be emailed to user-entered addresses via Ethernet connection
 - Maintenance alert settings for vacuum pump and refrigeration
 - Security lock out
- * USB port and Ethernet connection

- End-Zone compatible (End-Zone Starter Kit sold separately. See page 48)
- Hot gas defrost with auto shut off at +65° C (+149° F)
- Vacuum control valve
- * Vacuum break valve
- * Patented** moisture sensor
- Compact benchtop design with a small footprint
- Stainless steel and powder-coated steel exterior
- Quick-disconnect drain hose fitting with hose connector. 18", 1/4" ID silicone tubing and clamp included
- Electrical receptacle for vacuum pump connection
- 3/4" OD vacuum connection, 50" of 3/4" ID vacuum hose and two clamps

Models conform to the following standards:

- UL Standard 61010-1 (115/230V, 60 Hz models)
- CAN/CSA C22.2 No. 61010-1 (115/230V, 60 Hz models)
- CE Conformity marking (230V, 50 Hz models)

Options include:

- PTFE-coated collector coil and chamber for corrosive compounds
- Region-specific electrical plug configurations

All models require (not included):

- Vacuum pump with a displacement of at least 98 L/min, 0.002 mBar ultimate pressure and fitting for 3/4" ID vacuum hose. See pages 41-44
- Drying accessory. See pages 34, 36-39
- Freeze dry glassware if not bulk freeze drying. See pages 46, 50



* Labconco exclusive feature

**U.S. Patent No. 6,968,631

FreeZone® 8 Liter -50° C Benchtop Freeze Dryers

Ordering Information

Catalog Number Configurator:

Use this key to configure the nine digit catalog number to order your FreeZone 8 Liter -50° C Benchtop Freeze Dryer.

7 0 0 8 0 0

Select the **COLLECTOR COIL** and **CHAMBER MATERIAL** of your freeze dryer. This is the sixth digit of your catalog number.

- 1 = Stainless steel
- 2 = PTFE-coated stainless steel

Select the **ELECTRICAL CONFIGURATION** and **PLUG TYPE** of your freeze dryer. These are the eighth and ninth digits of your catalog number.

- 00 = 115V, 60 Hz, with 20A plug for North America
- 10 = 230V, 60 Hz, with plug for North America
- 15 = 230V, 60 Hz, with plug for Saudi Arabia
- 30 = 230V, 50 Hz, with Schuko plug
- 40 = 230V, 50 Hz, with plug for China/Australia
- 50 = 230V, 50 Hz, with plug for Great Britain (UK)
- 70 = 230V, 50 Hz, with plug for India

Electrical Requirements

Collector Capacity	Refrigeration Temperature	Volts	Amps	Note
8 L	-50° C	115	14*	Requires 20 amp dedicated circuit
8 L	-50° C	230	7**	

Plug Configurations



115V, 60 Hz, 20A for North America



230V, 60 Hz for North America



230V, 60 Hz for Saudi Arabia



230V, 50 Hz Schuko



230V, 50 Hz for China/Australia



230V, 50 Hz for Great Britain (UK)



230V, 50 Hz for India

Actual Dimensions & Shipping Weights

Refrigeration Temperature	Overall Dimensions (w x d x h)	Shipping Weight
-50° C (-58° F)	22.5" x 26.5" x 18.5" (57.2 x 67.3 x 47.0 cm)	130 lbs. (59 kg)

*System amperage shown includes 8 amp maximum vacuum pump rating.
 **System amperage shown includes 4.5 amp maximum vacuum pump rating.

FreeZone® 6, 12 & 18 Liter Console Freeze Dryers

Specifications



Application suitability:

- Moderate to large sample loads or numerous sample batches
- Compatible with the FreeZone Stoppering Tray Dryer or Bulk Tray Dryer (tray dryer sold separately)

All models feature:

- Upright stainless steel collector coil capable of holding 6, 12 or 18 liters of ice before defrosting. Collector lid, 3/4" thick, has neoprene gasket
- * Full color, 5" capacitive touch screen with Lyo-Works OS:
 - Real time display of collector temperature, vacuum level and optional End-Zone end point detection
 - Automatic and manual start-up modes for collector cool down and vacuum pull down
 - Vacuum set point, alerts, diagnostic tests, user manual, defrost control and optional drying accessory control
 - Data logging stores and displays data in table or graph format, and may be exported via USB
 - Settings include language (English, Spanish, French, German, or Italian), time, temperature (°C or °F) and vacuum (mBar, Torr or Pa)
 - Alerts can be emailed to user-entered addresses via Ethernet connection
 - Maintenance alert settings for vacuum pump and refrigeration
 - Security lock-out

* Labconco exclusive feature

- * USB port and Ethernet connection
- End-Zone compatible (End-Zone Starter Kit sold separately. See page 48)
- Vacuum control valve
- * Vacuum break valve
- * Patented* moisture sensor
- Console cabinet with interior space for vacuum pump (sold separately) and two-piece, removable front panel with viewing window
- Stainless steel and powder-coated steel exterior
- Quick-disconnect drain hose fitting with hose connector. 18", 1/4" ID silicone tubing and clamp included
- Clear acrylic chamber lid, 3/4" thick, with neoprene gasket
- Interior electrical receptacle for vacuum pump connection
- 3/4" OD vacuum connection, 36" of 3/4" ID vacuum hose and two clamps

Models conform to the following standards:

- UL Standard 61010-1 (115/230V, 60 Hz models)
- CAN/CSA C22.2 No. 61010-1 (115/230V, 60 Hz models)
- CE Conformity marking (230V, 50 Hz models)

Options include:

- Single 3/4 hp, 1 hp or 1-1/2 hp HCFC/CFC-free refrigeration system to cool collector to -50° C (-58° F) or two 1/3 hp or 3/4 hp HCFC/CFC-free refrigeration systems to cool collector to -84° C (-119° F). Collectors reaching -50° C include acrylic lid. Collectors reaching -84° C include stainless steel lid
- Purge valve
- PTFE-coated collector coil and chamber for corrosive compounds
- Built-in shell freezer with stainless steel bath, 5.5" w x 12.5" d x 7.5" h (30.5 x 14.0 x 19.0 cm), that includes 1/2 hp HCFC/CFC-free refrigeration system to cool heat transfer solution to -40° C (-40° F), 3/4" thick high-density polyethylene lid, neoprene gasket and quick-disconnect drain hose fitting and 18", 1/4" ID silicone tubing with clamp
- Built-in stainless steel mini vacuum drying chamber, 5.1" w x 13.0" d x 2.5" h (12.9 x 33.0 x 6.4 cm), that includes 50-watt heater with microprocessor control to +60° C (+140° F), 3/4" thick clear acrylic lid and neoprene gasket. (Chamber is not cooled.)
- Region-specific electrical plug configurations

All models require (not included):

- Vacuum pump with a displacement of at least 98 L/min, 0.002 mBar ultimate pressure and fitting for 3/4" ID vacuum hose. See pages 41-44
- Drying accessory. See pages 34, 36-39
- Freeze dry glassware if not bulk freeze drying. See pages 46, 50



*U.S. Patent No. 6,968,631

FreeZone® 6 & 12 Liter Console Freeze Dryers

Ordering Information

Catalog Number Configurator:

Use this key to configure the nine digit catalog number to order your FreeZone 6 or 12 Liter Console Freeze Dryer.



Select the **REFRIGERATION TEMPERATURE** of your freeze dryer's collector. This is the second digit of your catalog number.

0 = -50° C (-58° F). For samples containing water. Not for use with samples containing acetonitrile, methanol or ethanol. FreeZone 6 Liter collector is capable of removing 4 liters of water and FreeZone 12 Liter collector is capable of removing 8 liters of water in 24 hours.*

1 = -84° C (-119° F). For low eutectic point samples containing water or acetonitrile. Not for use with samples containing methanol or ethanol. FreeZone 6 Liter or 12 Liter collector is capable of removing 4 liters of water in 24 hours.*

Select the **CAPACITY** of your freeze dryer's collector. These are the third and fourth digits of your catalog number.

06 = 6 L **12** = 12 L

Select the **COLLECTOR COIL** and **CHAMBER MATERIAL** of your freeze dryer. This is the sixth digit of your catalog number.

1 = Stainless steel
2 = PTFE-coated stainless steel

Select the **BUILT-IN OPTION** of your freeze dryer. This is the seventh digit of your catalog number.

0 = None
1 = Purge Valve
2 = Purge Valve and Mini Chamber. Add 20 lbs. (9 kg) to shipping weight shown below.
3 = Purge Valve and Shell Freezer (FreeZone 6 Liter -50° C Freeze Dryers only). Add 80 lbs. (36 kg) to shipping weight shown below.

Select the **ELECTRICAL CONFIGURATION** and **PLUG TYPE** of your freeze dryer. These are the eighth and ninth digits of your catalog number. **The 115V configuration is available only on FreeZone 6 Liter Freeze Dryers.**

00 = 115V, 60 Hz, with 20A plug for North America
10 = 230V, 60 Hz, with plug for North America
15 = 230V, 60 Hz, with plug for Saudi Arabia
30 = 230V, 50 Hz, with Schuko plug
40 = 230V, 50 Hz, with plug for China/Australia
50 = 230V, 50 Hz, with plug for Great Britain (UK)
70 = 230V, 50 Hz, with plug for India

Electrical Requirements

Collector Capacity	Refrigeration Temperature	Volts	Amps	Note
6 L	-50° C & -84° C	115	16**	Requires 20 amp dedicated circuit
6 L	-50° C	230	8†	
6 L	-84° C	230	10**	
12 L	-50° C & -84° C	230	9†	

Plug Configurations



115V, 60 Hz, 20A
for North America



230V, 60 Hz
for North America



230V, 60 Hz
for Saudi Arabia



230V, 50 Hz
Schuko



230V, 50 Hz
for China/Australia



230V, 50 Hz
for Great Britain (UK)



230V, 50 Hz
for India

Actual Dimensions & Shipping Weights

Refrigeration Temperature	Overall Dimensions (w x d x h)	Shipping Weight (6 L)	Shipping Weight (12 L)
-50° C (-58° F)	31.8" x 29.6" x 36.6" (80.8 x 75.2 x 93.0 cm)	255 lbs. (116 kg)	275 lbs. (125 kg)
-84° C (-119° F)	31.8" x 29.6" x 36.6" (80.8 x 75.2 x 93.0 cm)	270 lbs. (122 kg)	320 lbs. (145 kg)

*Freeze drying rate will be lower for samples other than shell-frozen plain water. For optimum performance, room temperature should be 21° C (70° F) or colder.

**System amperage shown includes 8 amp maximum vacuum pump rating.

†System amperage shown includes 4.5 amp maximum vacuum pump rating.

FreeZone® 18 Liter -50° C Console Freeze Dryers

Ordering Information

Catalog Number Configurator:

Use this key to configure the nine digit catalog number to order your FreeZone 18 Liter -50° C Console Freeze Dryer capable of removing 10 liters of water in 24 hours:**



7 0 1 8 1

Select the **COLLECTOR COIL** and **CHAMBER MATERIAL** of your freeze dryer. This is the sixth digit of your catalog number.

- 1 = Stainless steel
- 2 = PTFE-coated stainless steel

Select the **BUILT-IN OPTION** of your freeze dryer. This is the seventh digit of your catalog number.

- 0 = None
- 1 = Purge Valve
- 2 = Purge Valve and Mini Chamber. Add 15 lbs. (7 kg) to shipping weight shown below.

Select the **ELECTRICAL CONFIGURATION** and **PLUG TYPE** of your freeze dryer. These are the eighth and ninth digits of your catalog number.

- 10 = 230V, 60 Hz, with plug for North America
- 15 = 230V, 60 Hz, with plug for Saudi Arabia
- 30 = 230V, 50 Hz, with Schuko plug
- 40 = 230V, 50 Hz, with plug for China/Australia
- 50 = 230V, 50 Hz, with plug for Great Britain (UK)
- 70 = 230V, 50 Hz, with plug for India

Electrical Requirements

Collector Capacity	Refrigeration Temperature	Volts	Amps
18 L	-50° C	230	9*

Plug Configurations



230V, 60 Hz
for North America



230V, 60 Hz
for Saudi Arabia



230V, 50 Hz
Schuko



230V, 50 Hz
for China/Australia



230V, 50 Hz
for Great Britain (UK)



230V, 50 Hz
for India

Actual Dimensions & Shipping Weights

Refrigeration Temperature	Overall Dimensions (w x d x h)	Shipping Weight
-50° C (-58° F)	31.8" x 29.6" x 36.6" (80.8 x 75.2 x 93.0 cm)	290 lbs. (132 kg)

*System amperage shown includes 4.5 amp maximum vacuum pump rating.

**Freeze drying rate will be lower for samples other than shell-frozen plain water. For optimum performance, room temperature should be 21° C (70° F) or colder.

FreeZone® Legacy™ 2.5 Liter Benchtop Freeze Dryers

Specifications

Application suitability:

- Light sample loads
- Limited floor space

All models feature:

- Upright stainless steel collector coil capable of removing 2 L of water in 24 hours and holding 2.5 L of ice before defrosting*
- 1/3 hp HCFC/CFC-free refrigeration system to cool collector to -50° C (-58° F). For aqueous samples. Not for use with samples containing acetonitrile, methanol or ethanol
- * LCD displays system operating parameters, set-up parameters and alarm messages. User configured to display vacuum in mBar, Torr or Pa and temperature in °C or °F. Also displays total hours of refrigeration system operation, time since refrigeration system was serviced, total number of hours of vacuum pump operation and time since the vacuum pump was serviced (in hours)
- LED vacuum and temperature “waves” for display of relative system vacuum and collector temperature
- Automatic start-up switch for collector cool-down and vacuum pull-down with manual override switches
- * Alarm flashes and beeps to indicate an abnormal system event has occurred, including: power failure, improper line voltage supply, collector temperature above -40° C, service vacuum pump (after 1000 hours of vacuum use) and moisture in collector. Pressing the Menu Switch displays the alarm message on the LCD
- RS-232 port to transmit data to a user-supplied computer. Transmission intervals may be user-configured for 10, 30, 60, 300 or 600 seconds
- * Patented** moisture sensor
- Vacuum control valve
- * Vacuum break valve
- Compact benchtop design with a small footprint
- Stainless steel and powder-coated steel exterior
- Clear acrylic lid with 3" dia. port for connection of drying accessories (drying accessory sold separately)
- Retractable 9" collector drain hose
- 3/4" OD vacuum connection, three feet of 3/4" ID vacuum hose and two clamps
- Electrical receptacle for vacuum pump connection
- Overall dimensions: 12.6" w x 17.9" d x 16.9" h (32.0 x 45.4 x 42.9 cm)

Models conform to the following standards:

- UL Standard 61010-1 (115/230V, 60 Hz models)
- CAN/CSA C22.2 No. 61010-1 (115/230V, 60 Hz models)
- CE Conformity marking (230V, 50 Hz models)



Options include:

- PTFE-coated collector coil and chamber for corrosive compounds
- Region-specific electrical plug configurations

All models require (not included):

- Vacuum pump with a displacement of at least 98 L/min, 0.002 mBar ultimate pressure and fitting for 3/4" ID vacuum hose. See pages 41-44
- Drying accessory with 7 digit catalog number. See pages 36-38
- Freeze dry glassware if not bulk freeze drying. See pages 46, 50



See ordering information at the bottom of page 23.

*Freeze drying rate will be lower for samples other than shell-frozen plain water. For optimum performance, room temperature should be 21° C (70° F) or colder.

**U.S. Patent No. 6,968,631

* Labconco exclusive feature

FreeZone® Legacy™ 6 Liter Benchtop Freeze Dryers

Specifications



Application suitability:

- Moderate sample loads
- Limited floor space

All models feature:

- Upright stainless steel collector coil with clear acrylic lid capable of removing 4 L of water in 24 hours and holding 6 L of ice before defrosting*
- 3/4 hp HCFC/CFC-free refrigeration system to cool collector to -50° C (-58° F). For aqueous samples. Not for use with samples containing acetonitrile, methanol or ethanol
- * LCD displays system operating parameters, set-up parameters and alarm messages. User configured to display vacuum in mBar, Torr or Pa and temperature in ° C or ° F. Also displays total hours of refrigeration system operation, time since refrigeration system was serviced, total number of hours of vacuum pump operation and time since the vacuum pump was serviced (in hours)
- LED vacuum and temperature “waves” for display of relative system vacuum and collector temperature
- Automatic start-up switch for collector cool-down and vacuum pull-down with manual override switches
- * Alarm flashes and beeps to indicate an abnormal system event has occurred, including: power failure, improper line voltage supply, collector temperature above -40° C, service vacuum pump (after 1000 hours of vacuum use) and moisture in collector. Pressing the Menu Switch displays the alarm message on the LCD
- RS-232 port to transmit data to a user-supplied computer. Transmission intervals may be user-configured for 10, 30, 60, 300 or 600 seconds
- * Patented** moisture sensor
- Vacuum control valve

* Vacuum break valve

- Stainless steel and powder-coated steel exterior
- Retractable 9" collector drain hose
- 3/4" OD vacuum connection, three feet of 3/4" ID vacuum hose and two clamps
- Electrical receptacle for vacuum pump connection
- 3" dia. port for connection of drying accessories (drying accessory sold separately)
- Overall dimensions: 31.8" w x 28.1" d x 14.5" h (80.8 x 71.4 x 36.8 cm)

Models conform to the following standards:

- UL Standard 61010-1 (115/230V, 60 Hz models)
- CAN/CSA C22.2 No. 61010-1 (115/230V, 60 Hz models)
- CE Conformity marking (230V, 50 Hz models)

Options include:

- PTFE-coated collector coil and chamber for corrosive compounds
- Region-specific electrical plug configurations

All models require (not included):

- Vacuum pump with a displacement of at least 98 L/min, 0.002 mBar ultimate pressure and fitting for 3/4" ID vacuum hose. See pages 41-44
- Drying accessory with 7 digit catalog number. See pages 36-39
- Freeze dry glassware if not bulk freeze drying. See pages 46, 50



See ordering information at the bottom of page 23.

*Freeze drying rate will be lower for samples other than shell-frozen plain water. For optimum performance, room temperature should be 21° C (70° F) or colder.

**U.S. Patent No. 6,968,631

* Labconco exclusive feature

Dry Ice Benchtop Freeze Dryer

Ordering Information

For occasional lyophilization requirements, the Dry Ice Benchtop Freeze Dryer provides a simple, economical means of freeze drying. Dry ice cools alcohol to approximately -75° C (-103° F), which is ideal for processing materials with low eutectic points. Center well for dry ice and solvent serves as a water vapor collector and doubles as a convenient pre-freezing bath.

7522700—Dry Ice Benchtop Freeze Dryer. Chamber, 8.8" dia. x 9.8" h (22.2 x 24.8 cm) type 304 stainless steel with 12 valves and capacity of 1 liter. Valves accommodate either 1/2" or 3/4" flask adapters. Includes dry ice/solvent center well with 1.92 liter capacity and cover, 1/2" OD port for connection to vacuum pump and 3/8" OD port for connection to vacuum gauge. **Dry ice, heat transfer solution, vacuum pump, vacuum gauge, tubing and glassware are required (not included).** See pages 41-43 for vacuum pumps and accessories. See pages 46 and 50 for glassware. Shipping weight 11 lbs. (5 kg)

7814300—Bleed Valve. Bleeds vacuum when all valves are in use on the Dry Ice Freeze Dryer. 1/2" OD connections. Shipping weight 0.5 lb. (0.2 kg)



FreeZone® Legacy™ 2.5 Liter Benchtop Freeze Dryers. See specifications on page 21.

Catalog Number	Electrical Requirements	Receptacle & Plug Type	PTFE-Coated Collector Coil & Chamber	Shipping Weight
7670520	115V, 60 Hz, 14A*	115V, 20A		85 lbs. (39 kg)
7670521	115V, 60 Hz, 14A*	115V, 20A	•	85 lbs. (39 kg)
7670540	230V, 60 Hz, 7A**	North America, 230V		85 lbs. (39 kg)
7670541	230V, 60 Hz, 7A**	North America, 230V	•	85 lbs. (39 kg)
7670530	230V, 50 Hz, 7A**	Schuko		85 lbs. (39 kg)
7670531	230V, 50 Hz, 7A**	Schuko	•	85 lbs. (39 kg)
7670560	230V, 50 Hz, 7A**	British (UK)		85 lbs. (39 kg)
7670561	230V, 50 Hz, 7A**	British (UK)	•	85 lbs. (39 kg)
7670570	230V, 50 Hz, 7A**	China/Australia		85 lbs. (39 kg)
7670571	230V, 50 Hz, 7A**	China/Australia	•	85 lbs. (39 kg)

FreeZone® Legacy™ 6 Liter Benchtop Freeze Dryers. See specifications on page 22.

Catalog Number	Electrical Requirements	Receptacle & Plug Type	PTFE-Coated Collector Coil & Chamber	Shipping Weight
7752020	115V, 60 Hz, 16A*	115V, 20A		150 lbs. (68 kg)
7752021	115V, 60 Hz, 16A*	115V, 20A	•	150 lbs. (68 kg)
7752040	230V, 60 Hz, 8A**	North America, 230V		150 lbs. (68 kg)
7752041	230V, 60 Hz, 8A**	North America, 230V	•	150 lbs. (68 kg)
7752030	230V, 50 Hz, 8A**	Schuko		150 lbs. (68 kg)
7752031	230V, 50 Hz, 8A**	Schuko	•	150 lbs. (68 kg)
7752060	230V, 50 Hz, 8A**	British (UK)		150 lbs. (68 kg)
7752061	230V, 50 Hz, 8A**	British (UK)	•	150 lbs. (68 kg)
7752070	230V, 50 Hz, 8A**	China/Australia		150 lbs. (68 kg)
7752071	230V, 50 Hz, 8A**	China/Australia	•	150 lbs. (68 kg)

Plug Configurations



115V, 60 Hz, 20A
for North America



230V, 60 Hz
for North America



230V, 50 Hz
Schuko



230V, 50 Hz
for Great Britain (UK)



230V, 50 Hz
for China/Australia

*System amperage shown includes 8 amp maximum vacuum pump rating.

**System amperage shown includes 4.5 amp maximum vacuum pump rating.

FreeZone® Legacy™ Triad™ Freeze Dryers

Features & Benefits

User-Friendly Control Panel

LCD displays shelf, sample and collector temperatures in °C or °F; vacuum in mBar, Torr or Pa.

MODE switch selects either manual or automatic operation.

VACUUM switch manually starts or stops vacuum pump.

DEFROST switch controls the hot gas defrost function.

Red LED Alarm indicator flashes and beeps to indicate an abnormal system event has occurred. Alarm messages are displayed on the LCD. The beeper mutes after one minute.

❖ **HCFC/CFC-free refrigeration system ensures environmentally-safe cooling.** Two refrigeration modules cool the collector coil to -85° C (-121° F), ideal for freeze drying samples with low eutectic points including acetonitrile. The same refrigeration system and a 1000-watt heater efficiently cool and heat the shelf. Temperature of the fluid circulating through channels in the shelf may be set to pre-freeze and then to lyophilize. The system uses a non-flammable refrigerant that contains no ozone-damaging hydrochlorofluorocarbons (HCFCs) or chlorofluorocarbons (CFCs).

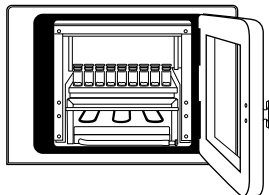

The shelf may be loaded with serum bottles with stoppers in the raised position.

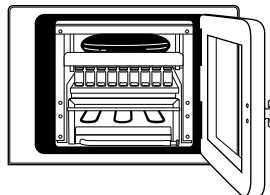

When the stoppering control is activated, atmospheric pressure causes diaphragm to expand. Pressure from expanding diaphragm forces the stoppering platen downward until it makes contact with stoppers, forcing them into the containers.

❖ **Collector drain pan and hose.** A stainless steel drain pan catches defrosted condensate, which may be conveniently emptied through the attached drain hose. The pan is removable for cleaning.



❖ **Built-in pneumatic mechanism stoppers containers on processing shelf.** Containers are stoppered while chamber is under vacuum and without the use of compressed gas.

Chamber pre-freezes samples to save money and time. Samples may be frozen on the shelf, eliminating the need for a separate freezer and product transfer.

Serum Bottle Capacity

Size	Catalog Number	Shelf Capacity
2 ml	7575010	400
3 ml	7575210	441
5 ml	7573010	233
10 ml	7573210	196
20 ml	7573410	121
30 ml	7573610	86
50 ml	7573810	64
100 ml	7574010	42
125 ml	7574210	36

❖ Labconco exclusive feature

FreeZone® Legacy™ Triad™ Freeze Dryers

Specifications & Ordering Information

All models feature:

- ❖ Two 1/3 hp HCFC/CFC-free refrigeration systems cool the collector to -85° C (-121° F) and work in concert with a 1000-watt heater to cool and heat fluid medium circulating through channels in the shelf. Fluid temperature may be set from -55° C to +50° C (-67° to +122° F) or to pre-freeze shelf temperature of -75° C (-103° F). Controls circulating fluid temperature to ±1° C of set point. For samples containing water or acetonitrile. Not for use with samples containing methanol or ethanol
- Stainless steel collector coil capable of removing 1.84 L of water in 24 hours and holding 2.5 L of ice before defrosting*
- Shelf, 12.4" w x 14.5" d (31.5 x 36.8 cm), for containers with stoppers up to a maximum height of 148 mm and minimum height of 31 mm
- Temperature programming from -55° C to +50° C (-67° to +122° F) during ramping and holding and -75° C (-103° F) during pre-freezing; and memory to store five programs, each with a pre-freeze segment plus five additional segments, for repetition of identical protocols
- ❖ Pneumatic stoppering mechanism with diaphragm and stoppering plate. **No compressed gas is required**
- One probe for monitoring sample temperature
- Four neoprene valve ports
- LCD that displays shelf, sample and collector temperature in ° C or ° F, vacuum in mBar, Torr or Pa. When in Automatic mode, LCD also displays the program selected, present segment that is ramping or holding, time remaining in present segment and end of program
- Control panel that includes Run/Stop, Mode, Enter, "Up" arrow, "Down" arrow, Vacuum, Defrost and Display switches; green indicator lights for Run/Stop, Automatic and Manual mode and Set Up, Automatic, Monitor and Manual display; red LED Alarm indicator; Stoppering control knob; Vacuum Release valve control knob; and 1/8" OD backfill port
- ❖ Alarm flashes and beeps to indicate an abnormal system event has occurred, including: shelf temperature variation more than ±2° C, collector temperature above -40° C, vacuum pressure changes more than 0.500 mBar, shelf temperature outside of set point during ramping, power failure, unevenly loaded shelf during stoppering and service vacuum pump (after 1000 hours of vacuum use). Alarm messages are displayed on the LCD. Sound mutes after one minute
- RS-232 port to transmit data to a user-supplied computer. Transmission intervals may be user-configured for 10, 30, 60, 300 or 600 seconds
- Vacuum control valve
- ❖ Vacuum break valve
- ❖ Hot gas defrost with auto shut off at +65° C (+149° F)
- ❖ Stainless steel and powder-coated steel exterior
- Large acrylic door, 1" thick, with neoprene gasket



- Stainless steel condensate pan with drain hose
- ❖ Electrical receptacle for vacuum pump connection
- Overall dimensions: 28.5" w x 29.5" d x 28.0" h (72.4 x 74.9 x 71.1 cm)

Models conform to the following standards:

- UL Standard 61010A-1 (230V, 60 Hz model)
- CAN/CSA C22.2 No. 1010-1 (230V, 60 Hz model)
- CE Conformity marking (230V, 50 Hz models)

All models require (not included):

- Vacuum pump with a displacement of at least 98 L/min, 0.002 mBar ultimate pressure and fitting for 3/4" ID vacuum hose. See pages 38-41
- Freeze dry glassware if not bulk freeze drying. See pages 46, 50



Catalog Number	Electrical Requirements	Receptacle & Plug Type	Shipping Weight
7400040	230V, 60 Hz, 12A	230V, 60 Hz for North America	450 lbs. (204 kg)
7400030	230V, 50 Hz, 12A	230V, 50 Hz Schuko	450 lbs. (204 kg)
7400060	230V, 50 Hz, 12A	230V, 50 Hz for Great Britain (UK)	450 lbs. (204 kg)
7400070	230V, 50 Hz, 12A	230V, 50 Hz for China/Australia	450 lbs. (204 kg)

See page 35 for FreeZone Triad accessories.

* Freeze drying rate will be lower for samples other than plain water. For optimum performance, room temperature should be 21° C (70° F) or colder.

❖ Labconco exclusive feature

FreeZone® Stoppering Tray Dryers

Features & Benefits

Stoppering knob controls shelf stoppering mechanism.

1/8" OD backfill port introduces inert gas from an outside source to the chamber, protecting samples from atmospheric moisture and contaminants.

Three sensor probes monitor sample temperature.

Pre-freeze samples on the shelves at a controlled rate (annealing). Improves sample quality and eliminates need for a separate freezer and product transfer.



Vacuum release valve control vents the chamber allowing the door to be opened.

Separate HCFC/CFC-free refrigeration system and 1000 watt heater ensure efficient cooling and heating of the shelves.

Optional built-in 6-Port Tray Dryer Manifold increases flexibility and capacity of the tray dryer. Samples may be simultaneously freeze dried in flasks or other glassware attached to the valves and on the tray dryer's shelves. Also available as a field-installable accessory. See page 35 for ordering information.

Optional built-in isolation valve separates the Stoppering Tray Dryer from the Freeze Dryer to shorten time necessary to reestablish working vacuum levels and to provide a means for checking end point. Also available as a field-installable accessory. See page 35 for ordering information.

Three large adjustable shelves accommodate bulk trays or batches of serum bottles or ampules. Samples may be lyophilized and then stoppered on the shelves.

FreeZone Stoppering Tray Dryers are ideal drying accessories for pharmaceutical research labs requiring stoppered bottles or vials of samples. Precise temperature control of the shelves lets you confidently pre-freeze and lyophilize samples. Order with your FreeZone Console Freezer Dryer as one catalog number on pages 29-30 or as a separate drying accessory component on page 31.



CE marking
All 230V, 50 Hz models conform to the CE (European Community) directives.



ETL listed
All 115/230V, 60 Hz models carry the ETL mark signifying they are certified to UL and CAN/CSA standards for laboratory equipment.

FreeZone® Stoppering Tray Dryers

Monitor & Control from Lyo-Works OS Display



FreeZone Stoppering Tray Dryer connects to any FreeZone Console Freeze Dryer with Lyo-Works OS. From your freeze dryer's large display, you have touch screen access to set and control your program's ramp rate, temperature, hold time and vacuum levels. Lyo-Works permits up to 30 different programs, each using as many as 16 different steps, to be stored and repeated for consistency and convenience.

Serum Bottle Capacity of the Stoppering Tray Dryer

Size	Catalog Number	Shelf Capacity	Number of Shelves	Total Capacity
2 ml	7575010	430	3	1290
3 ml	7575210	483	3	1449
5 ml	7573010	228	3	684
10 ml	7573210	195	3	585
20 ml	7573410	132	3	396
30 ml	7573610	86	3	258
50 ml	7573810	72	2	144
100 ml	7574010	42	2	84
125 ml	7574210	36	1	36

Built-in pneumatic mechanism stoppers containers on all three shelves.

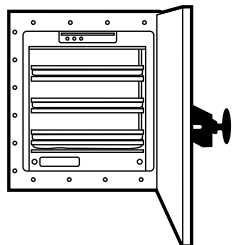

Load one to all three shelves with serum bottles or vials with stoppers in the raised position.

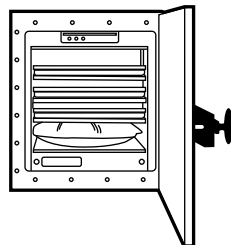

Turning the stoppering control knob causes the diaphragm to expand. The expanding diaphragm applies pressure to the bottom shelf causing it to rise until the shelf and its contents make contact with the shelf above it.

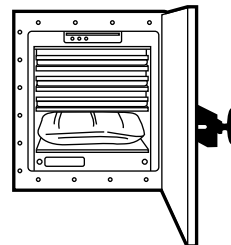

Diaphragm continues to expand until all three shelves have made contact with each other allowing all serum bottles to be stoppered under vacuum.

FreeZone® Stoppering Tray Dryers

Specifications



Application suitability:

- Moderate to large sample loads or numerous sample batches
- Stoppering vials or serum bottles under vacuum

All models feature:

- Three adjustable shelves, each 16.5" w x 12" d (41.9 x 30.5 cm) with 196 square inches of area. Spacing between the shelves accommodates containers with stoppers up to a maximum height of 75 mm and minimum height of 38 mm when three shelves are used, a maximum height of 107 mm and minimum height of 56 mm when two shelves are used, and a maximum height of 196 mm and minimum height of 114 mm when one shelf is used
- 1 hp HCFC/CFC-free refrigeration system and 1000-watt electric heater for cooling and heating fluid medium circulating through channels in the shelves from -40° C to +40° C (-40° to +104° F). Controls circulating fluid temperature to $\pm 1^\circ$ C of set point
- Three probes for monitoring sample or shelf temperature
- Pirani vacuum sensor
- Temperature ramp and hold programming from -40° C to +40° C (-40° to +104° F) and memory to store 30 programs with 16 segments each, including number of steps, ramp rate, shelf temperature, hold time and vacuum level

* Labconco exclusive feature

- * System programming that is displayed on the FreeZone 6, 12 or 18 Liter Freeze Dryer (freeze dryer sold separately or as one catalog number): Manual or Program mode; probe temperatures in ° C or ° F, vacuum in mBar, Torr or Pa; segment of the program that is in progress; time remaining in present segment; alarms for power failure; supply line voltage outside of limits; system temperature variation $> \pm 2^\circ$ C, vacuum variation > 0.500 mBar; failure to reach system set point temperature; and program completed
- * Data logging that displays and stores data in table or graph on the FreeZone 6, 12 or 18 Liter Freeze Dryer (freeze dryer sold separately or as one catalog number). Export data via USB or Ethernet
- Stoppering mechanism that inflates a diaphragm via atmospheric pressure. **No compressed gas is required**
- Stoppering Raise/Lower control knob, vacuum release Open/Close control knob and 1/8" OD backfill port for user-supplied air or gas
- Stainless steel and powder-coated steel exterior
- Acrylic door, 1" thick, with silicone gasket and latch
- 3" dia. outlet, located on the bottom of the tray dryer cabinet, for connection to a FreeZone 6, 12 or 18 Liter Console Freeze Dryer (freeze dryer is required and not included)
- Integral support stand
- Overall dimensions (tray dryer only): 32.4" w x 24.6" d x 27.1" h (82.3 x 62.4 x 68.8 cm)

Models conform to the following standards:

- UL Standard 61010-1 (115/230V, 60 Hz models)
- CAN/CSA C22.2 No. 61010-1 (115/230V, 60 Hz models)
- CE Conformity marking (230V, 50 Hz models)

Options include:

- 6-Port Tray Dryer Manifold, 30.0" w x 16.5" d x 7.0" h (76.2 x 41.9 x 17.8 cm). Available only when ordering the FreeZone Stoppering Tray Dryer as a separate component. See page 31
- Isolation Valve. Available only when ordering the FreeZone Stoppering Tray Dryer as a separate component. See page 31
- Region-specific electrical plug configurations

All models require (not included):

- FreeZone 6, 12 or 18 Liter Console Freeze Dryer with Lyo-Works OS. FreeZone Stoppering Tray Dryer and Freeze Dryer may be ordered as separate components or together as one catalog number on selected models of FreeZone 6, 12 or 18 Liter Console Freeze Dryers. See pages 18-20, 29-30
- Vacuum pump with a displacement of at least 163 L/min, 0.002 mBar ultimate pressure and fitting for 3/4" ID vacuum hose. See pages 41-44
- Freeze dry glassware if not bulk freeze drying. See pages 46, 50



FreeZone® 18 Liter -50° C Console Freeze Dryers with Stoppering Tray Dryer

Ordering Information



Catalog Number Configurator:

Use this key to configure the nine digit catalog number to order your FreeZone 18 Liter Console Freeze Dryer with Stoppering Tray Dryer capable of removing 10 liters of water in 24 hours**

7 0 1 8 2

Select the **COLLECTOR COIL** and **CHAMBER MATERIAL** of your freeze dryer. This is the sixth digit of your catalog number.

- 1 = Stainless steel
- 2 = PTFE-coated stainless steel

Select the **BUILT-IN OPTION** of your freeze dryer. This is the seventh digit of your catalog number.

- 0 = None
- 1 = Purge Valve

Select the **ELECTRICAL CONFIGURATION** and **PLUG TYPE** of your freeze dryer. These are the eighth and ninth digits of your catalog number.

- 10 = 230V, 60 Hz, with plug for North America
- 15 = 230V, 60 Hz, with plug for Saudi Arabia
- 30 = 230V, 50 Hz, with Schuko plug
- 40 = 230V, 50 Hz, with plug for China/Australia
- 50 = 230V, 50 Hz, with plug for Great Britain (UK)
- 70 = 230V, 50 Hz, with plug for India

Electrical Requirements

Collector Capacity	Refrigeration Temperature	Volts	Console Amps	Tray Dryer Amps
18 L	-50° C	230	9*	9

Plug Configurations



230V, 60 Hz
for North America



230V, 60 Hz
for Saudi Arabia



230V, 50 Hz
Schuko



230V, 50 Hz
for China/Australia



230V, 50 Hz
for Great Britain (UK)



230V, 50 Hz
for India

Actual Dimensions (Tray Dryer mounted on Console) & Shipping Weights (Two Cartons)

Refrigeration Temperature	Overall Dimensions (w x d x h)	Shipping Weight
-50° C (-58° F)	32.4" x 29.6" x 63.7" (82.3 x 75.2 x 161.8 cm)	713 lbs. (323 kg)

*System amperage shown includes 4.5 amp maximum vacuum pump rating.

**Freeze drying rate will be lower for samples other than shell-frozen plain water. For optimum performance, room temperature should be 21° C (70° F) or colder.

FreeZone® Stoppering Tray Dryers

Ordering Information



Catalog Number Configurator:

Use this key to configure the nine digit catalog number to order your FreeZone Stoppering Tray Dryer. To order your FreeZone Stoppering Tray Dryer and Freeze Dryer together as one catalog number, see pages 29 and 30.

Electrical Requirements

Volts	Amps
115	16
230	9

Shipping Weights

Built-In Options Included	Shipping Weight
None	423 lbs. (192 kg)
6-Port Tray Dryer Manifold	438 lbs. (199 kg)
Isolation Valve	431 lbs. (196 kg)
6-Port Tray Dryer Manifold and Isolation Valve	458 lbs. (208 kg)

Plug Configurations

115V, 60 Hz, 20A for North America	230V, 60 Hz for North America	230V, 60 Hz for Saudi Arabia	230V, 50 Hz Schuko	230V, 50 Hz for China/Australia	230V, 50 Hz for Great Britain (UK)	230V, 50 Hz for India

7 9 4 8 0 1

Select **BUILT-IN OPTIONS** for your tray dryer. This is the seventh digit of your catalog number.

- 0 = None
- 1 = 6-Port Tray Dryer Manifold
- 2 = Isolation Valve
- 3 = 6-Port Tray Dryer Manifold and Isolation Valve

Select the **ELECTRICAL CONFIGURATION** and **PLUG TYPE** of your freeze dryer. These are the eighth and ninth digits of your catalog number.

- 00 = 115V, 60 Hz, with 20A plug for North America
- 10 = 230V, 60 Hz, with plug for North America
- 15 = 230V, 60 Hz, with plug for Saudi Arabia
- 30 = 230V, 50 Hz, with Schuko plug
- 40 = 230V, 50 Hz, with plug for China/Australia
- 50 = 230V, 50 Hz, with plug for Great Britain (UK)
- 70 = 230V, 50 Hz, with plug for India

FreeZone® Bulk Tray Dryers

Specifications



Application suitability:

- Moderate to large bulk sample loads or numerous sample batches

All models feature:

- Three shelves, each 12.7" w x 16.6" d (32.2 x 42.2 cm) to provide 210 square inches of area. Chamber may accommodate two additional shelves (additional shelves sold separately)
- * 200-watt heater on each shelf for heating to +60° C (+140° F). Maintains system temperature within 3° C of set point. (Shelves are not cooled by the Bulk Tray Dryer. Samples must be pre-frozen)
- Three sensor probes for monitoring sample temperature. Connections for two additional sensors are provided (additional sensors sold separately)
- * System programming displayed on the FreeZone 6, 12 or 18 Liter Freeze Dryer (freeze dryer sold separately): Manual or Program mode; probe temperatures in ° C or ° F, vacuum in mBar, Torr or Pa; segment of the program in progress; time remaining in present segment; alarms; shelf temperature variation > ±3° C; failure to reach shelf set point temperature ±3° C; and program completed
- * Data logging, when enabled, stores and displays data in table or graph on the FreeZone 6, 12 or 18 Liter Freeze Dryer (freeze dryer sold separately). Export data via USB or Ethernet
- Vacuum release valve with knob
- Stainless steel and powder-coated steel exterior
- Acrylic door, 1" thick, with silicone gasket and latch

* Labconco exclusive feature

- 3" dia. outlet, located on the bottom of the tray dryer cabinet, for connection to a FreeZone 6, 12 or 18 Liter Console Freeze Dryer (freeze dryer sold separately)
- * Integral support stand with attachment port for connection to FreeZone 6, 12 or 18 Liter Console Freeze Dryer (freeze dryer sold separately)
- Overall dimensions: 32.2" w x 21.5" d x 27.1" h (81.8 x 54.6 x 68.8 cm)

Models conform to the following standards:

- UL Standard 61010-1 (115/230V, 60 Hz models)
- CAN/CSA C22.2 No. 61010-1 (115/230V, 60 Hz models)
- CE Conformity marking (230V, 50 Hz models)

Options include:

- 6-Port Tray Dryer Manifold, 30.0" w x 16.5" d x 7.0" h (76.2 x 41.9 x 17.8 cm)
- Isolation Valve

All models require (not included):

- FreeZone 6, 12 or 18 Liter Console Freeze Dryer with Lyo-Works OS. See pages 18-20
- Vacuum pump with a displacement of at least 163 L/min, 0.002 mBar ultimate pressure and fitting for 3/4" ID vacuum hose. See pages 41-44
- Freeze dry glassware if not bulk freeze drying. See pages 46, 50

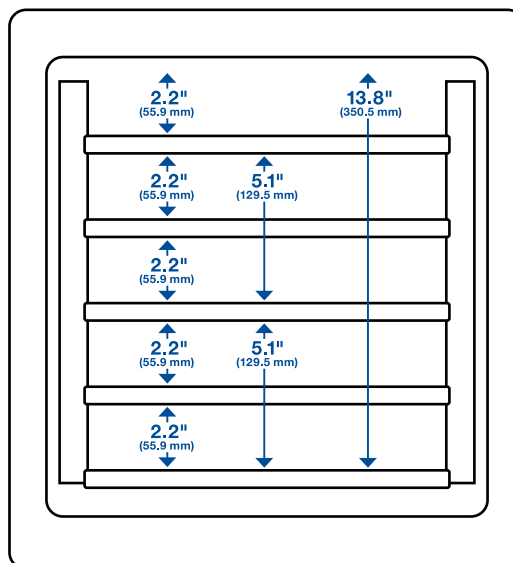

Shelf Spacing Dimensions

FreeZone® Bulk Tray Dryers

Ordering Information

Catalog Number Configurator:

Use this key to configure the nine digit catalog number to order your FreeZone Bulk Tray Dryer.

7 8 0 6 0 1

Select **OPTIONS** for your tray dryer. This is the seventh digit of your catalog number.

- 0 = None
- 1 = 6-Port Tray Dryer Manifold
- 2 = Isolation Valve
- 3 = 6-Port Tray Dryer Manifold and Isolation Valve

Select the **ELECTRICAL CONFIGURATION** and **PLUG TYPE** of your freeze dryer. These are the eighth and ninth digits of your catalog number.

- 00 = 115V, 60 Hz, with 15A plug for North America
- 10 = 230V, 60 Hz, with plug for North America
- 15 = 230V, 60 Hz, with plug for Saudi Arabia
- 30 = 230V, 50 Hz, with Schuko plug
- 40 = 230V, 50 Hz, with plug for China/Australia
- 50 = 230V, 50 Hz, with plug for Great Britain (UK)
- 70 = 230V, 50 Hz, with plug for India

Electrical Requirements

Volts	Amps
115	8
230	4

Shipping Weights

Options Included	Shipping Weight
None	248 lbs. (113 kg)
6-Port Tray Dryer Manifold	263 lbs. (119 kg)
Isolation Valve	256 lbs. (116 kg)
6-Port Tray Dryer Manifold and Isolation Valve	283 lbs. (128 kg)

Plug Configurations



115V, 60 Hz, 15A for North America



230V, 60 Hz for North America



230V, 60 Hz for Saudi Arabia



230V, 50 Hz Schuko



230V, 50 Hz for China/Australia



230V, 50 Hz for Great Britain (UK)



230V, 50 Hz for India



Heated Shelves with Sensors. 12.7" w x 17.0" d (32.2 x 43.2 cm). Stainless steel shelf includes 200-watt heater and temperature probe. FreeZone Bulk Tray Dryers include three and can accommodate two additional Heated Shelves with Sensors.

Catalog Number	Description	Shipping Weight
730151000	Heated Shelf with Sensor for 115V, 50/60 Hz operation	18 lbs. (9 kg)
730151010	Heated Shelf with Sensor for 230V, 50/60 Hz operation	18 lbs. (9 kg)
736581000	Replacement Temperature Probe only	0.5 lb. (0.2 kg)

FreeZone® Small Tray Dryers

Specifications & Ordering Information



- Acrylic door, 1" thick, with silicone gasket and latch
- Overall dimensions: 15.3" w x 18.5" d x 18.1" h (38.25 x 47.0 x 45.8 cm)

Models conform to the following standards:

- UL Standard 61010-1 (115/230V, 60 Hz models)
- CAN/CSA C22.2 No. 61010-1 (115/230V, 60 Hz models)
- CE Conformity marking (230V, 50 Hz models)

Options include:

- Region-specific electrical plug configurations

All models require (not included):

- FreeZone Freeze Dryer with Lyo-Works OS (not for use with FreeZone Legacy models)
- Vacuum pump with a displacement of at least 98 L/min, 0.002 mBar ultimate pressure and fitting for 3/4" ID vacuum hose. See pages 41-44
- Freeze dry glassware if not bulk freeze drying. See page 50



Application suitability:

- Small to moderate bulk sample loads or numerous sample batches

All models feature:

- Three removable shelves with shelf sensors, each 10.6" w x 12.0" d (26.9 x 30.5 cm) to provide 127.2 square inches of area. Chamber can accommodate two additional shelves (additional shelves sold separately)
- * 200-watt heater on each shelf for heating to +60° C (+140° F). Maintains shelf temperature within 3° C of set point. (Shelves are not cooled by the Tray Dryer)
- Three sensor probes for monitoring sample temperature. Connections for two additional sensors are provided (additional sensors sold separately)
- * System programming is displayed on any FreeZone 2.5, 4.5, 6, 8, 12 or 18 Liter Freeze Dryer (Freeze dryer sold separately. Not for use with FreeZone Legacy models.): Manual or Program mode; probe temperatures in °C or °F, vacuum in mBar, Torr or Pa; segment of the program in progress; time remaining in present segment; end of program; alarms; supply line voltage outside of limits; system temperature variation > ±2° C, vacuum variation > 0.500 mBar; failure to reach system set point temperature and program completed
- * Data logging that displays and stores data in table or graph on FreeZone Freeze Dryers with Lyo-Works OS. (Freeze dryer sold separately. Not for use with FreeZone Legacy models.) Data is exportable via USB or Ethernet
- Vacuum release valve with knob
- Stainless steel and powder-coated steel exterior

* Labconco exclusive feature

Catalog Number	Electrical Requirement	Receptacle & Plug Type
780701000	115V, 60 Hz, 5A	115V, 60 Hz for North America
780701010	230V, 60 Hz, 2.5A	230V, 60 Hz for North America
780701015	230V, 60 Hz, 2.5A	230V, 60 Hz for Saudi Arabia
780701030	230V, 50 Hz, 2.5A	230V, 50 Hz Schuko
780701040	230V, 50 Hz, 2.5A	230V, 50 Hz for China/Australia
780701050	230V, 50 Hz, 2.5A	230V, 50 Hz for Great Britain (UK)
780701070	230V, 50 Hz, 2.5A	230V, 50 Hz for India

Accessories



Heated Shelves with Sensors. 10.6" w x 12.0" d (26.9 x 30.5 cm). Stainless steel shelves include 200-watt heater and temperature probe. FreeZone Small Tray Dryers include three and can accommodate two additional Heated Shelves with Sensors.

Catalog Number	Description	Shipping Weight
730152000	Heated Shelf with Sensor for 115V, 50/60 Hz operation	15 lbs. (7 kg)
730152010	Heated Shelf with Sensor for 230V, 50/60 Hz operation	15 lbs. (7 kg)
736581000	Temperature Probe only	0.5 lb. (0.2 kg)

FreeZone® Tray Drying Accessories

Triad™, Stoppering, Bulk & Small Tray Dryers



726500—6-Port Tray Dryer Manifold. For use with FreeZone Stoppering and Bulk Tray Dryers. 30.0" w x 16.5" d x 7.0" h (76.2 x 41.9 x 17.8 cm). Six valves accommodate either 1/2" or 3/4" flask adapters. The 6-Port Tray Dryer Manifold and Isolation Valve 7761500 may not be field installed together. Shipping weight 19 lbs. (9 kg)



7204300—6-Port Tray Dryer Manifold and Isolation Valve. For use with FreeZone Stoppering and Bulk Tray Dryers. 30.1" w x 20.6" d x 13.5" h (76.5 x 52.3 x 34.3 cm). Six valves accommodate either 1/2" or 3/4" flask adapters. Shipping weight 45 lbs. (21 kg)

7761500—Isolation Valve. For use with FreeZone Stoppering and Bulk Tray Dryers. Separates tray dryer from freeze dryer to shorten time necessary to reestablish working vacuum levels and provide a means for checking end point. Consists of a valve, valve handle, clamps and couplings. The Isolation Valve and 6-Port Tray Dryer Manifold 726500 may not be field installed together. Shipping weight 5.0 lbs. (2.3 kg)

7756300—Shelf Spacers. For use with FreeZone Stoppering Tray Dryers. 9.0" w x 13.0" d x 2.5" h (22.9 x 33.0 x 6.4 cm). Type 304 stainless steel spacers placed on one or two empty shelves assist stoppering of partial loads of small serum bottles. One pair. Shipping weight 3.0 lbs. (1.4 kg)

Bulk Trays. Contain pre-frozen liquids for bulk drying. Type 304 stainless steel sheet with 0.9" (2.3 cm) lip. Shipping weight 3.0 lbs. (1.4 kg)



Catalog Number	Description	For Use With	Dimensions (w x d)
7377900	Small Tray	Stoppering, Bulk, Small	10.3" x 11.6" (26.2 x 29.5 cm)
7756200	Large Tray	Stoppering, Bulk	11.5" x 15.0" (29.2 x 38.1 cm)



7756100—Tray with Slide-Out Bottom. For use with FreeZone Stoppering and Bulk Tray Dryers. 12.0" w x 14.0" d (30.5 x 35.6 cm). Stainless steel tray has separate bottom that slides out to allow glassware containers direct contact with shelf. Shipping weight 5.0 lbs. (2.3 kg)



7369600—Microwell Plate Holder. Solid aluminum base holds a 127.8 x 85.5 mm microplate for excellent heat transfer and temperature stability for small samples susceptible to meltback. **Microwell plate not included.** 5.7" w x 8.0" d x 0.7" h (14.5 x 20.3 x 1.8 cm). One each. Shipping weight 2.0 lbs. (0.9 kg)

Rectangular Test Tube & Test Tube/Microcentrifuge Racks.

For use with any FreeZone Tray Dryer. Type 304 stainless steel rack, 12.0" w x 10.0" d x 2.5" h (30.5 x 25.4 x 6.4 cm), holds up to 70 each 12-13 mm test tubes. Test Tube/Microcentrifuge Rack has additional adapter plate for microcentrifuge tubes. **Tubes not included.**



Catalog Number	Description	Shipping Weight
7370000	Test Tube Rack	2.8 lbs. (1.3 kg)
7370001	Test Tube/Microcentrifuge Tube Rack	3.5 lbs. (1.6 kg)



7439300—Microcentrifuge Tube Holder. 3.0" w x 2.25" d x 1.0" h (7.6 x 5.7 x 2.5 cm). Anodized aluminum block accommodates twelve 1.7 ml microcentrifuge tubes. Holder may be placed on any flat freeze drying surface. One each. **Microcentrifuge tubes are not included.** Shipping weight 0.6 lb. (0.3 kg)



7516200—Support Grid. For use with any FreeZone Tray Dryer. 7.0" w x 7.0" d (17.8 x 17.8 cm). Stainless steel tray with removable plastic grid to hold ampules and other small specimen containers. Grid holds 144 containers of 12 mm dia. Shipping weight 2.5 lbs. (1.1 kg)

Drying Accessories

Chambers



12-Port Stainless Steel Drying Chambers. For use with any FreeZone Freeze Dryer. 8.0" dia. x 9.75" h (20.3 cm x 24.8 cm). Type 304 stainless steel. Include 1/2" thick acrylic lid with neoprene gasket and 12 neoprene valves with molded plastic knobs that accommodate both 1/2" and 3/4" adapters for connection of flasks.

Catalog Number	Interior Chamber Material	Shipping Weight
7522800	Type 304 stainless steel	11 lbs. (5 kg)
7522801	PTFE-coated type 304 stainless steel	11 lbs. (5 kg)



16-Port Stainless Steel Drying Chambers. For use with any FreeZone Freeze Dryer. 13.0" dia. x 13.0" h (33 x 33 cm). Type 304 stainless steel. Include 3/4" thick acrylic lid with neoprene gasket and 16 neoprene valves with molded plastic knobs that accommodate both 1/2" and 3/4" adapters for connection of flasks.

Catalog Number	Interior Chamber Material	Shipping Weight
7522900	Type 304 stainless steel	21 lbs. (10 kg)
7522901	PTFE-coated type 304 stainless steel	21 lbs. (10 kg)



Short Clear Chamber with Valves 7318802



Tall Clear Chamber with Valves 7318800



Short Clear Chamber 7318702



Tall Clear Chamber 7318700

Clear Chambers with Valves. For use with any FreeZone Freeze Dryer. Provide visibility into the acrylic chamber while allowing connection of freeze dry glassware to eight valves. Includes clear acrylic cylinder, anodized aluminum lid, eight neoprene valves with molded plastic knobs for use with 1/2" and 3/4" adapters, clear acrylic attachment port lid with 8" dia. opening and cap for 3" dia. attachment port on FreeZone Console Freeze Dryers.

Clear Chambers. For use with any FreeZone Freeze Dryer. Provide visibility into the chamber during bulk drying. Include clear acrylic lid with neoprene gasket, vacuum release valves and pass-through for electrical transformer cords, clear acrylic base with 8" dia. opening and cap for 3" dia. attachment port on FreeZone Console Freeze Dryers.

Catalog Number	Clear Chamber Type	Dimensions	Accommodate	Shipping Weight
7318802	Short Cylinder with Valves	Inside 11.5" dia. x 12.3" h (29.2 x 32.2 cm) Overall 17.4" dia. x 15.3" h (44.2 x 38.9 cm)	Short Product Shelves 7317100	22 lbs. (10 kg)
7318800	Tall Cylinder with Valves	Inside 11.5" dia. x 20.0" h (29.2 x 50.8 cm) Overall 17.4" dia. x 23.0" h (44.2 x 58.4 cm)	Short Product Shelves 7317200 Tall Product Shelves 7317100	25 lbs. (11 kg)
7318702	Short Cylinder	Inside 11.5" dia. x 12.4" h (29.2 x 31.5 cm) Overall 13.6" dia. x 16.8" h (34.5 x 42.7 cm)	Short Product Shelves 7317100	17 lbs. (8 kg)
7318700	Tall Cylinder	Inside 11.5" dia. x 20.2" h (29.2 x 51.3 cm) Overall 13.6" dia. x 24.6" h (34.5 x 62.5 cm)	Short Product Shelves 7317200 Tall Product Shelves 7317100	20 lbs. (10 kg)

Drying Accessories

Product Shelves

Product Shelves. Accommodate bulk samples, microwell plates or serum bottles. Consist of 10" dia. aluminum shelves (three or five depending on the model) with 1/4" rims, three stainless steel support rods and three rubber feet. Fit inside corresponding Clear and 16-Port Drying Chambers.

Catalog Number	Overall Dimensions	Number of Shelves	Shipping Weight
7317100	10.0" dia. x 9.8" h (25.4 x 24.9 cm)	3	4.5 lbs. (2.0 kg)
7317200	10.0" dia. x 17.5" h (25.4 x 44.5 cm)	5	7.0 lbs. (3.2 kg)



Short Product Shelves
7317100



Tall Product Shelves
7317200

Heated Product Shelf Chambers. For use with any FreeZone Freeze Dryer with Lyo-Works OS. For bulk drying of solid samples or batch drying of small serum bottles or vials. The 10" dia. adjustable shelves are wireless and removable so that they may be placed in a freezer for pre-freezing. Chamber connects to a FreeZone Freeze Dryer for control and recording of shelf temperature from the Lyo-Works display. Temperature settings from -4° C (25° F) to +60° C (140° F). Include 12" dia. clear acrylic cylinder, temperature probes, vacuum release valve, clear acrylic attachment port base with 8" dia. opening and cap for 3" dia. attachment port on FreeZone Console Freeze Dryers.



Short Heated Product Shelf Chamber 780801000



Tall Heated Product Shelf Chamber 780801100

Catalog Number	Overall Dimensions (w x d x h)	Number of Shelves & Probes	Electrical Configuration	Shipping Weight
780801000	13.5" x 15.2" x 17.0" (34.3 x 38.6 x 43.2 cm)	3	115V, 50/60 Hz for North America	80 lbs. (36 kg)
780801010	13.5" x 15.2" x 17.0" (34.3 x 38.6 x 43.2 cm)	3	230V, 50/60 Hz for North America	80 lbs. (36 kg)
780801015	13.5" x 15.2" x 17.0" (34.3 x 38.6 x 43.2 cm)	3	230V, 50/60 Hz for Saudi Arabia	80 lbs. (36 kg)
780801030	13.5" x 15.2" x 17.0" (34.3 x 38.6 x 43.2 cm)	3	230V, 50/60 Hz Schuko	80 lbs. (36 kg)
780801040	13.5" x 15.2" x 17.0" (34.3 x 38.6 x 43.2 cm)	3	230V, 50/60 Hz for China/Australia	80 lbs. (36 kg)
780801050	13.5" x 15.2" x 17.0" (34.3 x 38.6 x 43.2 cm)	3	230V, 50/60 Hz for British (UK)	80 lbs. (36 kg)
780801070	13.5" x 15.2" x 17.0" (34.3 x 38.6 x 43.2 cm)	3	230V, 50/60 Hz for India	80 lbs. (36 kg)
780801100	13.5" x 15.2" x 24.6" (34.3 x 38.6 x 62.5 cm)	5	115V, 50/60 Hz for North America	85 lbs. (39 kg)
780801110	13.5" x 15.2" x 24.6" (34.3 x 38.6 x 62.5 cm)	5	230V, 50/60 Hz for North America	85 lbs. (39 kg)
780801115	13.5" x 15.2" x 24.6" (34.3 x 38.6 x 62.5 cm)	5	230V, 50/60 Hz for Saudi Arabia	85 lbs. (39 kg)
780801130	13.5" x 15.2" x 24.6" (34.3 x 38.6 x 62.5 cm)	5	230V, 50/60 Hz Schuko	85 lbs. (39 kg)
780801140	13.5" x 15.2" x 24.6" (34.3 x 38.6 x 62.5 cm)	5	230V, 50/60 Hz for China/Australia	85 lbs. (39 kg)
780801150	13.5" x 15.2" x 24.6" (34.3 x 38.6 x 62.5 cm)	5	230V, 50/60 Hz for British (UK)	85 lbs. (39 kg)
780801170	13.5" x 15.2" x 24.6" (34.3 x 38.6 x 62.5 cm)	5	230V, 50/60 Hz for India	85 lbs. (39 kg)

736582000—Replacement Temperature Probe. For use with Heated Product Shelf Chambers. Shipping weight 0.5 lbs. (0.2 kg)

Heated Product Shelves. Ideal with FreeZone Legacy but compatible with any FreeZone Freeze Dryer. **Drying chamber required (see list below).** Consist of three aluminum shelves with 1/4" rims, three stainless steel support rods, nine clips for shelf height adjustment, low voltage transformer with variable heat control to +40° C (+104° F) and three rubber feet.

Catalog Number	Overall Dimensions	Electrical Requirements	Fit Inside Drying Chambers	Shipping Weight
7509200	6.5" dia. x 9.0" h (15.9 x 22.9 cm)	115V, 50/60 Hz	7522800, 7522801, 7522900, 7522901	13 lbs. (6 kg)
7509400	10.0" dia. x 11.75" h (24.5 x 29.8 cm)	115V, 50/60 Hz	7522900, 7522901	15 lbs. (7 kg)
7509201*	6.5" dia. x 9.0" h (15.9 x 22.9 cm)	230V, 50/60 Hz	7522800, 7522801, 7522900, 7522901	13 lbs. (6 kg)
7509401*	10.0" dia. x 11.75" h (24.5 x 29.8 cm)	230V, 50/60 Hz	7522900, 7522901	15 lbs. (7 kg)

*International electrical configuration



Drying Accessories

Test Tube Racks & Manifolds



Round Test Tube & Test Tube/Microcentrifuge Racks. For use with Product Shelves, Heated Product Shelf Chambers and Heated Product Shelves 7509400 and 7509401. Type 304 stainless steel rack, 9.0" dia. x 2.5" h (22.9 x 6.4 cm), holds up to 104 each 12-13 mm test tubes. Test Tube/Microcentrifuge Rack has additional adapter plate to accommodate 104 microcentrifuge tubes. **Tubes not included.**

Catalog Number	Description	Shipping Weight
7379000	12-13 mm Test Tube Rack	2.8 lbs. (1.3 kg)
7379001	12-13 mm Test Tube/Microcentrifuge Tube Rack	2.8 lbs. (1.3 kg)



7201700—4-Port Manifold.

For use with any FreeZone Freeze Dryer. 8.6" w x 8.6" d x 11.2" h (21.8 x 21.8 x 28.4 cm). Type 304 stainless steel, complete with four neoprene valves with molded plastic knobs that accommodate 1/2" and 3/4" adapters for connection of flasks. Shipping weight 5.5 lbs. (2.5 kg)



7201800—8-Port Manifold.

For use with any FreeZone Freeze Dryer. 8.6" w x 8.6" d x 15.7" h (21.8 x 21.8 x 39.9 cm). Type 304 stainless steel, complete with eight neoprene valves with molded plastic knobs that accommodate 1/2" and 3/4" adapters for connection of flasks. Shipping weight 8.5 lbs. (3.9 kg)



7201900—14-Port Manifold.

For use with any FreeZone Console Freeze Dryer. 24.3" w x 10.6" d x 10.3" h (61.7 x 26.9 x 26.2 cm). Type 304 stainless steel, complete with 14 neoprene valves with molded plastic knobs that accommodate 1/2" and 3/4" adapters for connection of flasks. Shipping weight 21 lbs. (10 kg)



7522300—20-Port Manifold.

For use with any FreeZone Freeze Dryer. 27.4" w x 8.7" d x 11.0" h (27.9 x 68.5 x 22.1 cm). Type 304 stainless steel, complete with 20 neoprene valves with molded plastic knobs that accommodate 1/2" and 3/4" adapters for connection of flasks. Shipping weight 15 lbs. (7 kg)



7202000—28-Port Manifold.

For use with any FreeZone Console Freeze Dryer. 24.3" w x 10.6" d x 18.3" h (61.7 x 26.9 x 46.5 cm). Type 304 stainless steel, complete with 28 neoprene valves with molded plastic knobs that accommodate 1/2" and 3/4" adapters for connection of flasks. Shipping weight 38 lbs. (17 kg)

Drying Accessories

Stoppering Chambers & Optional Lids

Clear Stoppering Chambers. For use with FreeZone 4.5 and 8 Liter Benchtop and 6, 12 and 18 Liter Console Freeze Dryers with Lyo-Works OS and FreeZone Legacy 6 Liter Benchtop Freeze Dryers. 13.5" dia. x 23.0" h (34.3 x 58.4 cm). Provides an economical means of stoppering serum bottles under original vacuum. Consists of clear acrylic cylinder, stainless steel top plate, two 10" dia. aluminum shelves and low voltage transformer with variable heat control to +40° C (104° F). Clear, 3/4" thick acrylic base has neoprene gasket, vacuum release valve and stoppering handle. Also includes 3/4" thick, clear acrylic attachment port base with 3" dia. opening, neoprene gasket and pass-through for electrical transformer cord. Two shelves accommodate samples. When lyophilization is complete handle is turned to collapse top plate onto shelves, stoppering samples under vacuum. Accommodates small containers from 2 to 5 milliliters.



Catalog Number	Electrical Requirements	Shipping Weight
7868020	115V, 50/60 Hz	30 lbs. (14 kg)
7868030	230V, 50/60 Hz	30 lbs. (14 kg)



7569000—Mini Stoppering Chamber. Ideal for lyophilizing samples in small bottles with split stoppers. Mini Stoppering Chamber attaches to a neoprene valve on any Labconco Drying Chamber or Manifold. Once samples are lyophilized, the bottles can be stoppered under vacuum. Accommodates up to forty-eight 2 milliliter bottles or eight 30 milliliter serum bottles. Stoppering travel distance is 0.5" (12.7 mm). Using zero, one or two of the spacers provided, the chamber can accommodate bottles that range in height from 1.38" (35 mm) to 2.48" (63 mm). Includes one tray, two spacers; 1" OD and 1/2" ID PVC tubing, 36" long; two hose clamps; and 1/2" dia. stainless steel connector. Shipping weight 15 lbs. (7 kg)

Optional Lids. Stainless Steel and Glass Lids provide additional protection from solvents and corrosives that attack acrylic, such as acetonitrile. Lids with 3" dia. holes allow direct connection of a drying chamber or manifold to the collector. A cap is provided to close off the freeze dryer's 3" dia. attachment port when not in use.



Stainless Steel Lid 7207500



Acrylic Lid 7208200

Catalog Number	Lid Type	Description	Shipping Weight
7207400	Stainless Steel	14.0" dia., with neoprene gasket and 3" dia. hole for direct connection of drying accessories to collector. Includes cap for 3" dia. attachment port. For FreeZone 4.5, 6, 8, 12 and 18 Liter Freeze Dryers.	5.0 lbs. (2.3 kg)
7207500	Stainless Steel	10.1" dia., with neoprene gasket and 3" dia. hole for direct connection of drying accessories to collector. Includes cap for 3" dia. attachment port. For FreeZone 2.5 Liter Freeze Dryers.	5.0 lbs. (2.3 kg)
7208200	Acrylic	14.0" dia., with neoprene gasket and 3" dia. hole for direct connection of drying accessories to collector. Includes cap for 3" dia. attachment port. For FreeZone 6, 12 and 18 Liter Freeze Dryers.	5.0 lbs. (2.3 kg)
7439902	Glass	14.0" dia., with neoprene gasket, for FreeZone 6, 12 and 18 Liter Freeze Dryers and 16-Port Drying Chamber.	3.5 lbs. (1.6 kg)
7439900	Glass	9.25" dia., with neoprene gasket, for 12-Port Drying Chamber.	2.0 lbs. (0.9 kg)

Secondary Traps

Liquid Nitrogen, Chemical, HEPA & Dry Ice

7386500—HEPA Filter Trap. Fits between the freeze dryer and vacuum pump to prevent particulate contaminants from entering the pump. Shipping weight 15 lbs. (7 kg)



7394800—Liquid Nitrogen Secondary Trap. For processing samples with ultra low eutectic points. Secondary Trap connects between a freeze dryer and vacuum pump to prevent contaminants from migrating into the pump. Liquid nitrogen cools to -196°C (-321°F) to trap contaminants with low eutectic points. Powder-coated steel construction. $3/4"$ OD inlet and outlet connections. Includes an insulated filler tube for connection to a user-supplied liquid nitrogen tank; 20" wire-reinforced PVC tubing, $3/4"$ ID; and two clamps. **Liquid nitrogen is required (not included).** Shipping weight 24 lbs. (11 kg)

Chemical Traps. Traps are connected between the cold trap and the accessory vacuum pump to provide additional protection to the vacuum pump.



Clear Polypropylene Canister 7815302 with Solvent Trap Insert 7815200



7538000—Dry Ice Secondary Trap. For processing samples with low eutectic points. Connects between a freeze dryer and vacuum pump to prevent contaminants from migrating into the pump. Dry ice and solvent cools the insulated well to approximately -75°C (-103°F). When used alone, Dry Ice Secondary Trap may serve as an inexpensive collector. Connect a sample directly to the incoming port and add a vacuum pump to the outgoing port. Ice trapping capacity of 900 ml. Includes 3.1 L well and $3/4"$ OD inlet and outlet connections. Shipping weight 9.0 lbs. (4.1 kg). **Dry ice and solvent, such as alcohol, are required (not included).**





Catalog Number	Description	Shipping Weight
7815302	Clear Polypropylene Canister with stand Accommodates any trap insert listed below.	5.0 lbs. (2 kg)
7814800	Acid Trap Insert Contains acid neutralizing desiccant which changes from off-white to purple when exhausted.	4.0 lbs. (1.8 kg)
7814900	Moisture Trap Insert Contains desiccant which changes from blue to pink when exhausted.	4.0 lbs. (1.8 kg)
7815000	Radioisotope Trap Insert Contains activated carbon.	4.0 lbs. (1.8 kg)
7815200	Solvent Trap Insert Contains molecular sieve.	4.0 lbs. (1.8 kg)
7995600	Ammonia Trap Insert Contains impregnated carbon.	4.0 lbs. (1.8 kg)

Vacuum Pumps

Selection Guide & Accessories

The Rotary Vane, Combination and Scroll Vacuum Pumps provide the deep vacuum needed for good freeze drying results and fit easily into the cabinets of FreeZone Console Freeze Dryers.

Use the Selection Guides below to find the recommended Rotary Vane, Combination and/or Scroll Vacuum Pump based on your sample type and FreeZone Freeze Dryer's electrical configuration.

FreeZone Model	Sample Contains	Pump Type	Recommend Pump (≥98 lpm)*		Recommended Pump (≥163 lpm)		Page Number
			115 Volts	230 Volts	115 Volts	230 Volts	
 Benchtop 2.5, 4.5, 6 & 8 Liter or Dry Ice Freeze Dryer	Water	Rotary Vane	1472100	7739402	1467700	7739403	43
	Acids & Solvents	Combination	7584000	7584002			42
	Acids & Solvents	Scroll			7587000	7587002	44
 Console 6, 12 & 18 Liter	Water	Rotary Vane	1472100	7739402	1467700	7739403	43
	Acids & Solvents	Combination	7584000	7584002			42
	Acids & Solvents	Scroll			7587000	7587002	44
 Console 6, 12 & 18 Liter with Stoppering Tray Dryer, Bulk Tray Dryer or Tall Clear Chamber	Water	Rotary Vane			1467700	7739403	43
	Acids & Solvents	Scroll			7587000	7587002	44
 Legacy Triad	Water	Rotary Vane	1472100	7739402	1467700	7739403	43
	Acids & Solvents	Combination	7584000	7584002			42
	Acids & Solvents	Scroll			7587000	7587002	44

Rotary Vane and Combination Vacuum Pump Accessories

1472200—Inlet Filter. For Rotary Vane Vacuum Pumps 1472100, 7739400, 7739402, 1467700, 7739401 and 7739403. Prevents oil back streaming from the pump and protects pump from submicron particle damage. Includes filter assembly and one filter cartridge. Life is approximately 1000 hours at 1.33×10^{-2} mBar (10 microns) vacuum. Shipping weight 1.0 lb. (0.5 kg)

1472500—Replacement Inlet Filter Cartridge. For 1472200. Shipping weight 0.5 lb. (0.2 kg)

1473400—Replacement Exhaust Filter. For Rotary Vane Vacuum Pumps 1472100, 7739400, 7739402, 1467700, 7739401 and 7739403. Removes oil mist and odor from pump exhaust. Ducting to outside not required. Includes filter assembly, one oil mist filter cartridge and one odor filter cartridge. Oil mist filter cartridge life is approximately one year and odor filter cartridge life is approximately six months at 1.33×10^{-2} mBar (10 microns) vacuum. Shipping weight 1.0 lb. (0.5 kg)

1473200—Replacement Oil Mist Exhaust Filter Cartridge. For 1473400. Life is approximately one year at 1.33×10^{-2} mBar (10 microns) vacuum. Shipping weight 0.5 lb. (0.2 kg)

1473300—Replacement Odor Exhaust Filter Cartridge. For 1473400. Life is approximately one year at 1.33×10^{-2} mBar (10 microns) vacuum. Package of five. Shipping weight 0.5 lb. (0.2 kg)

7584300—VACUUBRAND B-Oil.** One liter. Replacement oil for Combination Vacuum Pumps 7584000 and 7584002. Shipping weight 2.0 lbs. (0.9 kg)

7541300—Vacuum Pump Oil. One gallon (3.8 L) synthetic hydrocarbon oil. Shipping weight 12 lbs. (5 kg)

1473500—Oil Return Kit. Allows extended operation of the pump with the ballast open and helps to keep oil purged of contaminants. Consists of a stainless steel cylinder and tubing with clamp. When the excess oil collects in the filter, it is directed back to the pump to conserve oil. Shipping weight 0.5 lb. (0.2 kg)

Vacuum Pump Oil. Hydro-treated paraffinic hydrocarbon oil. Replacement oil for Rotary Vane Vacuum Pumps 1472100, 7739400, 7739402, 1467700, 7739401 and 7739403.

Catalog Number	Volume	Shipping Weight
1988000	One liter	2.0 lbs. (0.9 kg)
1988001	One gallon (3.8 L)	12 lbs. (5 kg)

*Faster freeze drying rates may be achieved by using pumps with larger displacement capacities.

**VACUUBRAND™ and VACUUBRAND HYBRID™ are trademarks of VACUUBRAND GMBH + CO KG.

Rotary Vane Vacuum Pumps



General Purpose Rotary Vane Vacuum Pumps

- Designed for use with aqueous samples
- Compatible with FreeZone Freeze Dryers, CentriVap® Centrifugal Concentrators and Protector® Controlled Atmosphere Glove Boxes
- Ultimate vacuum (total pressure) 2×10^{-3} mBar (1.5 micron)
- On/off switch. Two inlet adapters (1/2" and 3/4" OD). Cast aluminum casing and rubber feet
- Mode selector with two positions: High Vacuum and High Throughput
- Gas ballast with three positions: Closed, Low Flow and High Flow
- Single phase direct drive motor, totally enclosed and fan cooled. Should the motor overheat, the thermal overload device switches off the pump. When the pump cools down, the motor automatically restarts
- Isolation valve seals the inlet to prevent oil and air contamination of the system in the event of power failure
- Include four each one liter bottles of vacuum pump oil and one exhaust filter with oil mist and odor filter elements
- Retractable lifting handle (1472100, 7739400 and 7739402)
- Lifting bracket (1467700, 7739401 and 7739403)

Catalog Number	Electrical Configuration	Displacement at 60 Hz (50 Hz) L/min	Dimensions (w x d x h)	Shipping Weight
1472100	115V, 50/60 Hz, 4.6A Includes 115V NEMA 5-15P plug	117 (98)	6.5" x 17.0" x 10.4" (15.8 x 43.0 x 26.1 cm)	62 lbs. (28 kg)
7739400*	230V, 50/60 Hz, 2.4A Includes 220V NEMA 6-15P plug	117 (98)	6.5" x 17.0" x 10.4" (15.8 x 43.0 x 26.1 cm)	62 lbs. (28 kg)
7739402	230V, 50/60 Hz, 2.4A Includes 230V reverse IEC plug	117 (98)	6.5" x 17.0" x 10.4" (15.8 x 43.0 x 26.1 cm)	62 lbs. (28 kg)
1467700	115V, 50/60 Hz, 7.8A Includes 115V NEMA 5-15P plug	195 (163)	6.5" x 18.5" x 10.4" (15.8 x 47.0 x 26.1 cm)	65 lbs. (30 kg)
7739401*	230V, 50/60 Hz, 4.0A Includes 220V NEMA 6-15P plug	195 (163)	6.5" x 18.5" x 10.4" (15.8 x 47.0 x 26.1 cm)	65 lbs. (30 kg)
7739403	230V, 50/60 Hz, 4.0A Includes 230V reverse IEC plug	195 (163)	6.5" x 18.5" x 10.4" (15.8 x 47.0 x 26.1 cm)	65 lbs. (30 kg)

*Not for direct electrical connection to FreeZone Freeze Dryers in this catalog.

Combination Vacuum Pumps



VACUUBRAND HYBRID* Vacuum Pumps

- Designed for use with acids and other harsh chemicals including TFA, TFA by-products, acetonitrile, HBe and HNO₃ present in samples such as HPLC-prepared and peptide purified materials
- Compatible with FreeZone Freeze Dryers and CentriVap Centrifugal Concentrators
- Comprised of a two-stage rotary vane pump and two-stage, chemical-resistant diaphragm pump. Provide deep vacuum required for good freeze drying and evaporation and have superior solvent and acid handling capabilities
- Low maintenance, longer lasting. The diaphragm pump, made of PTFE and other chemical-resistant fluoropolymer components, removes the condensable vapors in the rotary vane pump before they can contaminate the oil, thus extending the life of the oil and ultimately the life of the pump
- Environmentally-friendly. Pump oil lasts up to 10 times longer than in conventional rotary vane pumps under virtually all conditions. Fewer oil changes conserves resources
- Ultimate vacuum (partial pressure) 2×10^{-3} mBar (1.5 micron)
- Pressure control valve compensates for the different volumes displaced by the two pumps
- Glass separator captures downstream condensate vapors
- Lifting handle
- 3/4" OD inlet adapter
- Include one liter bottle of vacuum pump oil, power switch, power cord and plug

Catalog Number	Electrical Configuration	Displacement at 60 Hz (50 Hz) L/min	Dimensions (w x d x h)	Shipping Weight
7584000	115V, 60 Hz, 5.1A Includes 115V NEMA 5-15P plug	115 (98)	20.0" x 12.0" x 9.1" (51.0 x 30.5 x 23.0 cm)	66 lbs. (30 kg)
7584002	230V, 50/60 Hz, 2.7A Includes 230V reverse IEC plug	115 (98)	20.0" x 12.0" x 9.1" (51.0 x 30.5 x 23.0 cm)	66 lbs. (30 kg)

*VACUUBRAND HYBRID™ is a trademark of VACUUBRAND GMBH + CO KG.

Scroll Vacuum Pumps



Scroll Vacuum Pumps

- Low maintenance, longer lasting. Since these dry pumps do not require oil, lifetime operation costs are lower and less maintenance is needed compared to oil pumps
- Designed for use with acids below 20% concentration and solvents including acetonitrile
- Compatible with FreeZone Freeze Dryers, RapidVap® Dry Evaporation Systems and CentriVap Centrifugal Concentrators
- Two spiral scrolls compress air and vapors to move them toward the exhaust
- Environmentally-friendly. Oil-free design has no hydrocarbons
- Ultimate vacuum (partial pressure) 2×10^{-3} mBar (5.3 micron)
- Vacuum without contamination. Lubricant-free within the vacuum envelope and hermetically-sealed environment renders a totally clean and dry vacuum to prevent cross contamination
- Advanced scroll-form and tip-seal technologies deliver best-in-class vacuum performance and ultimate vacuum levels
- Unique tip seal design significantly reduces wear to minimize maintenance and extend service life

- Quiet operation of <52 dB(A) for minimal environmental impact
- Glass separator captures downstream condensate vapors
- 3/4" OD inlet adapter
- Include power switch, power cord and plug

Vacuum Pump Accessories

7587300—Pump Silencer. Filters exhaust while silencing exhaust pump noise. Includes filter, centering ring and clamp to attach to exhaust outlet. Shipping weight 2.0 lbs. (0.9 kg)

7587400—Pump Silencer Replacement Filter. For 7587300. Shipping weight 2.0 lbs. (0.9 kg)

7587200—Tip Seal Replacement Kit. Includes two tip seals, two o-rings, exhaust valve and spring and other small components. Shipping weight 2.0 lbs. (0.9 kg)

7587500—Bearing Replacement Service Kit. Includes contact bearings, shaft end cap, washers, screws, plugs and o-rings. Shipping weight 2.0 lbs. (0.9 kg)

Catalog Number	Electrical Configuration	Displacement at 60 Hz (50 Hz) L/min	Dimensions (w x d x h)	Shipping Weight
7587000	115V, 60 Hz, 5.1A Includes 115V NEMA 5-15P plug	195 (189)	20.0" x 12.0" x 15.0" (51.0 x 30.5 x 38.1 cm)	59 lbs. (26 kg)
7587002	230V, 50/60 Hz, 2.7A Includes 230V reverse IEC plug	195 (189)	20.0" x 12.0" x 15.0" (51.0 x 30.5 x 38.1 cm)	59 lbs. (26 kg)

PrimeMate™ Oil Change Systems



PrimeMate Oil Change System reduces the hassle and mess of changing the oil in your rotary vane or combination pump. Depending on your pump, the PrimeMate performs up to four oil changes before the clean oil container must be replaced or refilled and the used oil container emptied. In less than 13 minutes, used oil is drained and the pump filled with clean oil. A quick connect coupler attached to your pump's drain port provides easy tube attachment.

Components include powder-coated steel housing with lift off cover; one empty 1 gallon (3.8 L) plastic used oil container; one empty 1 gallon (3.8 L) plastic clean oil container; two peristaltic pumps (one fill and one drain); 6' (1.83 m) drain/fill flexible tubing with connectors; power switch; drain switch; fill switch; and indicator lights for 'power', 'draining', 'filling' and 'waste full'. Also includes 12V DC power supply, power cord with plug and male 1/4 NPT coupler for connection to user-supplied rotary vane vacuum pump. *Note: coupler fits rotary vane vacuum pumps sold by Labconco Corporation. If user-supplied pump has a drain port not compatible with a 1/4 NPT coupling connection, a suitable adapter will be required. See accessories.* Dimensions: 16.4" w x 13.4" d x 15.75" h (41.6 x 33.9 x 40.0 cm). Shipping weight 32 lbs. (15 kg)

Catalog Number	Electrical Requirements	Plug Type
7357020	115V, 60 Hz, 1A	115V, 15A NEMA 5-15P
7357030	230V, 50/60 Hz, 0.5A	230V, Schuko CEE 7/7
7357035	230V, 50/60 Hz, 0.5A	230V, British (UK) PS 1363
7357037	230V, 50/60 Hz, 0.5A	230V, China/Australia CHI-10P
7357040	230V, 50/60 Hz, 0.5A	230V, North America NEMA 6-15P



Battery Packs. Provide up to 8 hours of power to the PrimeMate when electricity is not accessible. Mount to the back of the PrimeMate. Battery, bracket, charger and fasteners are provided. **Installation is required.** Shipping weight 7.0 lbs. (3.2 kg)

Catalog Number	Battery Pack For Use With
7358900	PrimeMate 7357020 & 7357040
7358901	PrimeMate 7357030
7358902	PrimeMate 7357035
7358903	PrimeMate 7357037

7358501—Coupler. Quick connecting. For attaching the drain/fill tubing to vacuum pumps with 1/4 NPT plug threads. Useful when PrimeMate is servicing multiple vacuum pumps. **One per pump is required.** One is supplied with each PrimeMate. Shipping weight 0.5 lb. (0.2 kg)

7358700—Adapter. For attaching the drain/fill coupler to vacuum pumps with 7/8-14 drain plug threads. **Requires Coupler 7358501 (one included with each PrimeMate).** Shipping weight 0.5 lb. (0.2 kg)

See page 51 for accessory carts.

Fast-Freeze® Flasks & Adapters



Fast-Freeze Flasks. Select your flasks based on your sample sizes. Flasks should be filled to no more than one-third of their volume. Each Fast-Freeze Flask includes a rubber top, glass bottom and a supply of filter paper. Amber-colored glass helps to protect light-sensitive samples. Tops, bottoms and filter paper are available to purchase separately as replacement components at labconco.com. **Adapters are required (not included) to attach flasks to freeze dry valve ports.**

Flask Size	Clear Flask Catalog Number	Amber Flask Catalog Number	Flask Top Diameter*	Dimensions/Adapter (h x d)	Shipping Weight
40 ml	7540000		1/2"	76 x 34 mm	1.0 lb. (0.5 kg)
80 ml	7540200		1/2"	115 x 34 mm	1.0 lb. (0.5 kg)
120 ml	7540300		3/4"	68 x 59.2 mm	1.0 lb. (0.5 kg)
150 ml	7540400		3/4"	85 x 59.2 mm	1.0 lb. (0.5 kg)
300 ml	7540600	7540601	3/4"	145 x 59.2 mm	1.5 lbs. (0.7 kg)
600 ml	7540800	7540801	3/4"	135 x 90.2 mm	2.0 lbs. (0.9 kg)
750 ml	7541100	7541101	3/4"	162 x 90.2 mm	2.0 lbs. (0.9 kg)
900 ml	7540900	7540901	3/4"	190 x 90.2 mm	2.2 lbs. (1.0 kg)
1200 ml	7541000		3/4"	240 x 90.2 mm	2.2 lbs. (1.0 kg)
2000 ml	7541200		3/4"	380 x 90.2 mm	2.2 lbs. (1.0 kg)

7540100—FreeZone Freeze Dry Glassware Kit. Includes one each 600 ml Fast-Freeze Flask 7540800, one each 300 ml Fast-Freeze Flask 7540600, one each 3/4" dia. Stainless Steel Straight Adapter 7547200, and one each 3/4" dia. Stainless Steel 45° Bend Adapter 7547600. Shipping weight 5.0 lbs. (2.0 kg)

7544810—Replacement Filter Paper. 1000 (10 packages of 100). 1" dia. (28 mm). Pore size 17 microns. Shipping weight 0.5 lb. (0.2 kg)

Visit labconco.com for ordering information on Lyph-Lock® Flasks and replacement Fast-Freeze Flask tops and bottoms.

Compatible with all major brands of laboratory freeze dry apparatus

Variety of adapters available

Top seals easily. The flexible silicone rubber top snaps on and off easily, and provides reliable, high vacuum seal.

No complex filter retainer is necessary. For those who use filters, they are easily inserted between adapter and top of flask. One hundred filters supplied with each flask.

Only two pieces per flask. The complete Fast-Freeze Flask has only two components:

- High strength borosilicate glass bottom to withstand extreme temperatures and high vacuum
- Flexible, non-contaminating silicone rubber top

Wide mouth opening loads fast, cleans easily.

Available in 10 convenient sizes

Entire flask may be autoclaved.

No vacuum grease necessary

Flat bottom reduces spills, provides better balance.

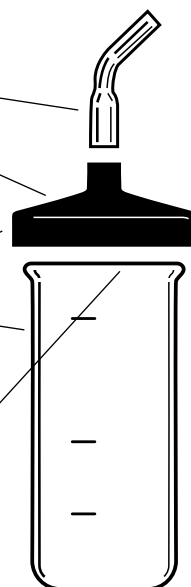

Adapters. Required for operation.

Connect Fast-Freeze Flasks to the valve ports on your drying chamber or manifold. Borosilicate glass or stainless steel adapters in 1/2" and 3/4" dia. Shipping weight 0.5 lb. (0.2 kg)

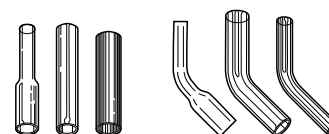

Description	Straight Adapter	45° Bend Adapter
Stainless Steel		
1/2" flask top to 1/2" valve*	7547000	7547400
3/4" flask top to 3/4" valve*	7547200	7547600
Borosilicate Glass		
1/2" flask top to 1/2" valve*	7545000	7545600
3/4" flask top to 3/4" valve*	7545200	7545800
1/2" flask top to 3/4" valve*	7545400	7546000
3/4" flask top to 1/2" valve*	7545400	7546000

*Valves on the freeze dryers, drying chambers and manifolds fit adapters with both 1/2" and 3/4" dia.

Fast-Freeze® Flask Accessories



7442600

7442700



7379400

7379500

Tube Holders. Stainless steel. Hold tubes in an upright position inside a 750 ml or larger Fast-Freeze Flask or Lyph-Lock Flask. **Tubes and glassware are not included.** Shipping weight 1.0 lb. (0.5 kg)

Catalog Number	Tube Capacity	Tube Description	Dimensions (h x d)	For Use with Flask	Shipping Weight
7442600	15	12 or 13 mm dia.	144 x 83.3 mm	750 ml or larger	1.0 lb. (0.5 kg)
7442700	30	0.5, 1.0 and 2.0 ml microcentrifuge	139 x 83.3 mm	750 ml or larger	1.0 lb. (0.5 kg)
7379400	9	15 ml, 17 x 20 mm	170 x 88.9 mm	900 ml or larger	1.0 lb. (0.5 kg)
7379500	4	50 ml, 30 x 116 mm	170 x 88.9 mm	900 ml or larger	1.0 lb. (0.5 kg)

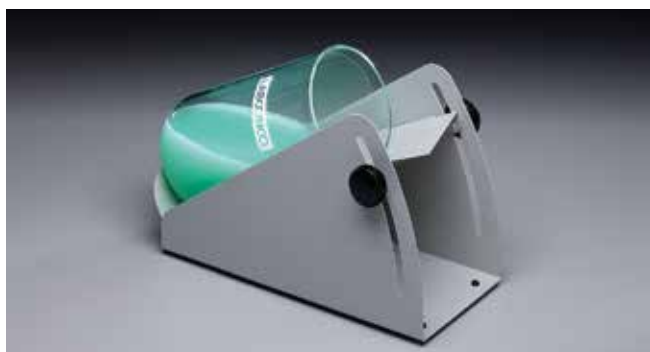

7369700—Slant Freeze Flask Holder. Slant freezing increases the surface area to volume ratio, maximizing freeze drying rate. Angle is manually adjustable from 5° to 35°. Powder-coated steel. 10.4" w x 4.5" d x 6.7" h (26.4 x 11.4 x 17.0 cm). Shipping weight 3.5 lbs. (1.6 kg)

7543900—Aseptic Adapter. For use with 120 ml to 2000 ml Fast-Freeze Flasks in place of an adapter. Allows a flask to be filled under sterile conditions prior to lyophilization and transported in a closed position before and after lyophilization. 3/4" OD for connection between a Fast-Freeze Flask with 3/4" top dia. and a valve port on any drying chamber or manifold in this catalog. Corrosion-resistant PTFE. 1.75" w x 0.75" d x 3.2" h (4.4 x 1.9 x 8.1 cm). Shipping weight 0.5 lb. (0.2 kg)



7543800—Stainless Steel Adapter 29/32. Allows connection of 29/32 round bottom flasks to valve ports on drying chambers and manifolds. Shipping weight 1.0 lb. (0.5 kg)



Flask Holders. Help to prevent sample meltback. Hold small Fast-Freeze Flask containing the sample inside a larger Fast-Freeze Flask so that sample is insulated. Stainless steel. **Flasks not included.** Shipping weight 1.0 lb. (0.5 kg)

Catalog Number	Description
7543300	Small Flask Holder Compatible with inner flasks 7540000 (40 ml) and 7540200 (80 ml) and outer flasks 7541100 and 7541101 (750 ml) and 7540900 and 7540901 (900 ml).
7543400	Large Flask Holder Compatible with inner flasks 7540300 (120 ml), 7542400 (150 ml) and 7540600 and 7540601 (300 ml) and outer flasks 7540900 and 7540901 (900 ml) and 7541000 (1200 ml).

End-Zone™ Starter Kit & Add-On Kit

Specifications & Ordering Information



End-Zone Starter Kit 780901000 is shown connected to FreeZone 4.5 Liter Benchtop Freeze Dryer 700401000 with 8-Port Manifold 7201800



End-Zone Starter Kit 780901000

780901000—End-Zone Starter Kit. Has components for detecting end point in one flask. Includes powder-coated steel 6-position sensor holder, two vacuum sensors with communication cables, one valve adapter and one top for 600 ml or larger Fast-Freeze Flask. **FreeZone Freeze Dryer with Lyo-Works OS, drying chamber or manifold, vacuum pump, 600 ml or larger Fast-Freeze Flask and Adapter are required for operation (not compatible with FreeZone Stoppering Tray Dryers, Bulk Tray Dryers or FreeZone Legacy Freeze Dryers).** Shipping weight 3.0 lbs. (1.4 kg)

* Labconco Exclusive Feature

End-Zone provides an alternative to visual inspection, eliminating the guesswork of knowing when lyophilization is complete. End-Zone alerts when sample moisture levels are below your specified value. It detects when end point has been reached by comparing the vacuum level of an empty valve to the vacuum level inside a Fast-Freeze Flask containing a sample. Lyo-Works shows the end point alert on your freeze dryer's display and, if programmed, sends an email.

The **End-Zone Starter Kit** has all the components needed to detect end point in one 600 ml or larger Fast-Freeze Flask:

- 26-pin cable for connecting the End-Zone sensors to any FreeZone Freeze Dryer with Lyo-Works (freeze dryer sold separately)
- Holder, mountable to the freeze dryer, with space for up to six sensors
- Two vacuum sensors—a sample sensor for placement in the Fast-Freeze Flask and a reference sensor for placement in an empty valve port
- Valve adapter to facilitate connection of sensor to empty valve port
- Fast-Freeze Flask top with opening for insertion of the vacuum sensor (flask bottom is required)

The **End-Zone Add-On Kit** comes with an additional vacuum sensor with communication cable and flask top. Up to four End-Zone Add-On Kits may be used.

780902000—End-Zone Add-On Kit. Includes one vacuum sensor with communication cable, one valve adapter, one top for 600 ml or larger Fast-Freeze Flask. **Requires End-Zone Starter Kit.** Shipping weight 3.0 lbs. (1.4 kg)

FreeZone® Benchtop Shell Freezers

All models feature:

- Stainless steel and powder-coated steel exterior
- 1/2 hp HCFC/CFC-free refrigeration system to cool the heat transfer solution to -40° C (-40° F)
- Stainless steel bath, 5.5" w x 12.0" d x 6.5" h (14.0 x 30.5 x 16.5 cm), surrounded by urethane foam insulation with white high-density polyethylene cover. Two chain-driven rollers, powered by a sparkless induction motor, rotate flasks up to 1200 ml. **Approximately two liters of transfer solution are required (not included)**
- LED temperature "wave" for display of bath temperature from -20° to -42° C (-4 to -43.6° F). LEDs illuminate amber as the system cools
When system reaches operating temperature, bottom LED illuminates green
- Retractable drain hose
- Overall dimensions: 15.1" w x 22.1" d x 19.7" h (38.4 x 56.1 x 50.0 cm)

Models conform to the following standards:

- UL Standard 61010-1 (115/230V, 60 Hz models)
- CAN/CSA C22.2 No. 61010-1 (115/230V, 60 Hz models)
- CE Conformity marking (230V, 50 Hz models)

Option includes:

- Region-specific electrical configurations



Fast-Freeze Flask Capacity

Flask Size	Quantity
40 ml	2
80 ml	2
120 ml	2
150 ml	2
300 ml	1
600 ml	1
750 ml	1
900 ml	1
1200 ml	1

FreeZone Benchtop Shell Freezers provide a compact system for pre-freezing samples for lyophilization. The stainless steel bath has two rollers that rotate Fast-Freeze Flasks in a low temperature heat transfer solution, such as methanol or ethanol, so that a uniform thin coating of sample freezes to the interior surface of the container. Shell freezing increases the surface area to volume ratio, which facilitates efficient vapor flow from sample to collector during lyophilization.

Catalog Number	Electrical Requirements	Plug Type	Shipping Weight
7949020	115V, 60 Hz, 6A	115V, 15A	96 lbs. (44 kg)
7949040	230V, 60 Hz, 3A	North America, 230V	96 lbs. (44 kg)
7949030	230V, 50 Hz, 3A	Schuko	96 lbs. (44 kg)
7949060	230V, 50 Hz, 3A	British (UK)	96 lbs. (44 kg)
7949070	230V, 50 Hz, 3A	China/Australia	96 lbs. (44 kg)

Serum Bottles, Ampules & Accessories



Serum Bottles. Specifically designed for lyophilization, Labconco Serum Bottles have uniform thin walls to even freezing and drying. They fit on shelves in tray dryers and connect to valve ports on manifolds and drying chambers. Serum Bottles, Stoppers and Seals supplied in packages of 100.

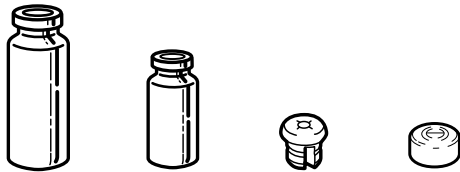

Size	20 mm Corkage	13 mm Corkage	Split Stoppers	Aluminum Seals
2 ml		7575010	7576010	7577010
3 ml		7575210	7576010	7577010
5 ml	7573010		7576210	7577110
10 ml	7573210		7576210	7577110
20 ml	7573410		7576210	7577110
30 ml	7573610		7576210	7577110
50 ml	7573810		7576210	7577110
100 ml	7574010		7576210	7577110
125 ml	7574210		7576210	7577110

Seal Crimpers. Secure tear-away Aluminum Seals.

7578000—Seal Crimper. For 13 mm corkage. Shipping weight 3.0 lbs. (1.4 kg)

7578100—Seal Crimper. For 20 mm corkage. Shipping weight 3.0 lbs. (1.4 kg)

Ampules. High quality borosilicate glass for strength and durability. Package of 100.

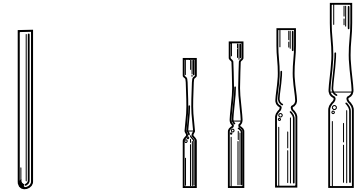

Size	Straight	Pre-Scored Flat Bottom
1 ml	7572710	7570610
2 ml		7570810
5 ml		7571010
10 ml		7571210

Ampule Pods. Allow multiple ampules to attach to a single drying chamber or manifold valve port to maximize sample capacity. Polypropylene base with 15 silicone tubing ports, 15 plugs and two clamps. Include one straight stainless steel adapter for connection to a drying accessory valve port. 3.8" w x 3.8" d x 7.5" h (9.7 x 9.7 x 19.1 cm). Shipping weight 2.5 lbs. (1.1 kg)



Catalog Number	Tubing Port Diameter
7205100	1/4" ID
7205101	3/8" ID

7593401—Ampule Valve Adapters. Connect ampules to valve ports. 10 per package. Shipping weight 0.5 lb. (0.2 kg)

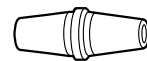

7762700—Three Way Adapter. Permits attachment of three ampules to a single valve port. Ampules are attached using Ampule Valve Adapters 7593401 or 1/8" surgical tubing (valve adapters and tubing not provided). Cavity in adapter body can be filled with cotton fiber media to help prevent contamination between samples. Shipping weight 0.2 lb. (0.1 kg).

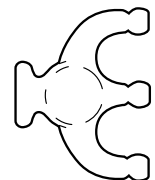

7578500—Oxygen/Natural Gas Sealing Torch. Specifically designed for flame sealing freeze dry ampules. Seals all types of heat-resistant glass. Connects to natural gas, butane or propane and oxygen with 1/4" ID hose connectors. Shipping weight 3.0 lbs. (1.4 kg)



Carts, Shelves & Gauges



7368700—FreeZone Cart. Powder-coated steel cart supports FreeZone Benchtop, Legacy Benchtop and Triad Freeze Dryers. 5.0" dia. (12.7 cm) casters. Bottom shelf accommodates a vacuum pump. 23.3" (59.2 cm) between shelves. Load capacity of 450 lbs. (204 kg). 28.0" w x 28.0" d x 31.3" h (71.1 x 71.1 x 79.5 cm). Shipping weight 120 lbs. (54 kg)



7426400—Support Shelves. Attach easily to the sides of the FreeZone Benchtop, Legacy Benchtop and Triad Freeze Dryers (left side only) to provide support for large flasks attached to the drying chamber or manifold. Multiple rows of perforations on the FreeZone cabinet allow for height adjustment of the shelves to support flasks of various sizes. One pair. Powder-coated steel. Each shelf is 7.4" w x 12.0" d (18.7 x 30.5 cm). Shipping weight 2.0 lbs. (0.9 kg)



8007000—Utility Cart. Upper shelf supports FreeZone 2.5 Liter -50° C Freeze Dryer, PrimeMate or other small equipment for transport. Lower 2.0" (5.1 cm) deep powder-coated steel removable watertight pan holds lightweight supplies. Power strip with 115 volts, 60 Hz, 12 amps capacity, has 6 electrical outlets, cord bracket and a 12' (3.7 m), 3-wire cord and plug. Two corrosion-resistant, one-piece, vacuum-formed ABS plastic drawers, 15.75" w x 14.9" d x 4.2" h (40.0 x 37.8 x 10.7 cm), hold small supplies. 4.0" dia. (10 cm) casters, two with toe locks. Load capacity of 400 lbs. (181 kg). Lifetime guarantee. 34.9" w x 19.0" d x 36.4" h (88.6 x 48.3 x 92.4 cm). Shipping weight 70 lbs. (32 kg)



Digital Electronic Vacuum Gauges. LCD displays vacuum measurement in mBar, Torr or Pa. Range is 0.02 mBar to 5 mBar. Stainless steel and powder-coated steel casing, 8.1" w x 4.1" d x 6.4" h (20.6 x 10.4 x 16.3 cm). Include a cord with 3/8" to 1/2" OD adapter for connection to either vacuum tubing or a valve on a drying accessory. All FreeZone and FreeZone Legacy Freeze Dryers include a vacuum gauge. The Dry Ice Benchtop Freeze Dryer or other freeze dryers may use the Digital Electronic Vacuum Gauge as an accessory.

Catalog Number	Electrical Requirements	Shipping Weight
7395000	115V, 60 Hz, 0.4A	10 lbs. (5 kg)
7395001*	230V, 50 Hz, 0.2A	10 lbs. (5 kg)

*International electrical configuration

Everything you need to succeed.

Ventilated Enclosures & Exhausters

Fume Hoods & Enclosures
Filtered Fume Hoods
Ductless (Carbon-Filtered) Enclosures
Biological Safety Cabinets & Enclosures
Clean Benches
PCR Enclosures
Balance, Bulk Powder & Equipment Enclosures
Nanotechnology Enclosures
Laboratory Animal Research Stations
Non-ventilated Enclosures
Remote Blowers & Exhausters

Sample Preparation Equipment

Freeze Dryers
Nitrogen Blow Down Dry Evaporators
Vacuum Dry Evaporators
Vacuum Concentrators
Cold Traps

Glassware Washers

Water Purification Systems

Glove Boxes & Gas Purifiers

Controlled Atmosphere Glove Boxes
Filtered Glove Boxes
Combination Glove Boxes

Forensic Enclosures

Kjeldahl, Fat & Crude Fiber Apparatus

Other Products

Laboratory Carts, Tables & Benches
Blood Drawing Chairs
Vacuum Desiccator
Base Stands, Base Cabinets & Work Surfaces
Filters & Prefilters
Vacuum Pumps
Freeze Dryer Accessories
Ventilation Product Accessories





Labconco Executive Management Team

Our promise.

You can expect straight talk from us. A fair and honest approach to doing business. And people you can trust to do the right thing.

When you buy equipment from us, it should work the way you need it to, and if it doesn't, we will take care of it.

Taking care of people is how we take care of business.



**Visit labconco.com to request information
for all Labconco products.**

LABCONCO CORPORATION

8811 Prospect Avenue
Kansas City, MO 64132

(800) 821-5525 | (816) 333-8811

labconco.com

©2017 LABCONCO CORPORATION

Printed in the U.S.A.

Product design subject to change without notice.

0-00-00/00/17

